

Green Room[®]

BY WILLAB GARDEN

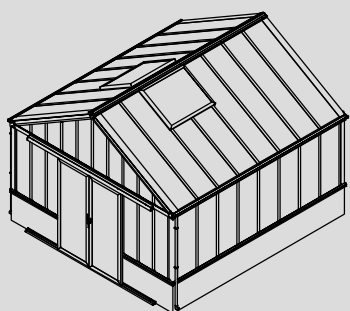

3731

421 × 396 × 328cm

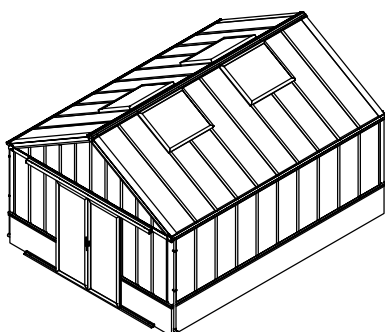

3732

521 × 396 × 328cm

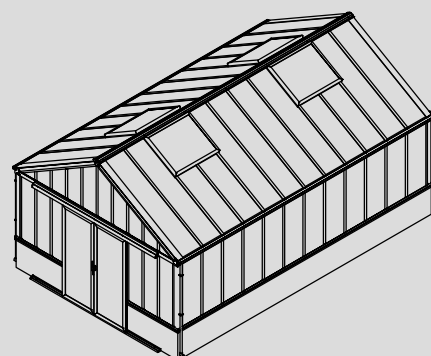

3733

621 × 396 × 328cm

Product size (L×W×H):

Storlek (L×B×H):

Størrelse (L×B×H):

Størrelse (L×B×H):

Koko (P×L×K):









Please read carefully before assembling.
Two people are needed.













Läs noggrant innan montering.
Det krävs två personer för montering.















































Læs venligst omhyggeligt, før montering.
Der kræves to personer til montering.













Les monteringsanvisningen nøye innen montering.
Det kreves to personer for montering.



Lue ohjeet huolellisesti läpi ennen asentamista.
Asentamiseen tarvitaan kaksi henkilöä.

Part	3731		3732		3733		QTY.	Code	Page
	NO.	Length (MM)	NO.	Length (MM)	NO.	Length (MM)			
	41A-Y11-4	4239	41A-Y11-5	5240	41A-Y11-6	6241	2	A001	P2
	41A-Y11-4A	3962	41A-Y11-5A	4963	41A-Y11-6A	5964	2	A002	P2
	41X-Y62-4	4228	41X-Y62-5	5229	41X-Y62-6	6230	2	A003	P4
	41X-Y63-4	4207	41X-Y63-5	5208	41X-Y63-6	6209	1	A004	P6
	41X-Y62-4BR	4228	41X-Y62-5BR	5229	41X-Y62-6BR	6230	1	A005	P9
	41X-Y62-4BL	4228	41X-Y62-5BL	5229	41X-Y62-6BL	6230	1	A006	P9
	41X-Y15-4	4239	41X-Y15-5	5240	41X-Y15-6	6241	2	A007	P12
	41X-Y63-4A	4207	41X-Y63-5A	5208	41X-Y63-6A	6209	2	A008	P18
	41X-Y62-4A	4228	41X-Y62-5A	5229	41X-Y62-6A	6230	2	A009	P27

Part	NO.	QTY.			Length(MM)	Page
		3731	3732	3733		
	41A-Y30	14	16	18	1335	P5
	51X-Y33R	2	4	4	2148	P8
	51X-Y33L	2	4	4	2148	P8
	51X-Y33	2	0	2	2148	P8
	41X-Y35	3	4	5	1500	P10
	41A-Y01	14	16	18	1335	P12
	51X-Y06	6	8	10	2216	P17
	41X-Y07	2	4	4	950	P17
	41X-Y80	2	4	4	1087	P25
	41X-Y81	4	8	8	887	P25
	41X-Y84	4	8	8	1076	P25
	41X-Y83	4	8	8	887	P25





























Part	NO.	QTY.	Length(MM)	Page	Part	NO.	QTY.	Length(MM)	Page
	51A-Y12	1	3990	P2		41A-Y97-B	2	1918	P21
	51A-Y13R	1	1270	P2		41A-Y97-A	2	1918	P21
	51A-Y13L	1	1270	P2		41A-Y97-R	1	1951	P21
	50A-Y12-A	1	3773	P2		41A-Y97-L	1	1951	P21
	51A-Y13R-A	1	1161	P2		41A-Y94	1	1946	P21
	51A-Y13L-A	1	1161	P2		41A-Y98-R	1	2000	P22
	41A-Y20	4	1336	P3		41A-Y98-L	1	2000	P22
	51X-Y61	1	3774	P4		41A-Y99	1	1410	P22
	51X-Y60	1	3774	P4		41A-Y100	1	1410	P22
	51X-Y32	2	1074	P6		41A-Y64	1	3016	P23
	51X-Y21	2	2149	P7		41A-Y17	1	3120	P23
	51X-Y22	2	2149	P7		41A-Y98A-R	1	1923	P23
	51X-Y31R	2	629	P7		41A-Y98A-L	1	1923	P23
	51X-Y31L	2	629	P7		41X-Y61-A	1	3023	P27
	51A-Y14L	1	1270	P12		51X-Y60-A	1	3774	P27
	51A-Y14R	1	1270	P12		51X-Y60-B	1	375	P27
	51X-Y14	1	3990	P12					
	41A-Y02	8	1335	P12					
	51X-Y03	2	1074	P14~15					
	51X-Y04R	2	629	P14~15					
	51X-Y04L	2	629	P14~15					
	51X-Y05R	2	2147	P14~15					
	51X-Y05L	2	2147	P14~15					
	51X-Y06B	4	2216	P17					
	41A-Y90	2	1958	P19					
	41A-Y91R	1	1958	P19					
	41X-Y92R	1	776	P19					
	41X-Y93	2	776	P19					
	41A-Y91L	1	1958	P19					
	41X-Y92L	1	776	P19					
				1b/30					

Part	NO.	QTY.			Length(MM)	Page
		3731	3732	3733		
	M8-20	60	68	68	PCS	P3~8
	Si8-16	132	152	172	PCS	P3~10
	7B33-020	137	157	177	PCS	P3~23
	7C33-001	16	24	24	PCS	P3~8
	7C28-004	25	29	33	PCS	P9~23
	Z4.2-13	30	34	38	PCS	P9~21
	J12	111	129	141	PCS	P11~25
	7B33-019	6	8	10	PCS	P17
	Z4.2-50	15	17	19	46	P18~23
	W04	24	32	32	PCS	P19~25
	W02	8	16	16	PCS	P25
	T07	4	8	8	PCS	P26













	7C26-007N	38.5M	42.5M	46.5M		P13~16
	7C26-022	8.5M	17M	17M		P25

Part	NO.	QTY.	Length(MM)	Page	Part	NO.	QTY.	Length(MM)	Page
	7B33-001	4	PCS	P2		7C33-S02	2	PCS	P28
	W03	12	30	P2~19		7C33-S03	4	PCS	P29
	PS8-80	20	PCS	P2~22		Z4.8-25	4	PCS	P29
	J09	8	PCS	P2		7B33-015L	2	PCS	P30
	7B33-002	4	PCS	P3		7B33-015R	2	PCS	P30
	7B33-003	4	PCS	P3		7C33-004	4	PCS	P30
	J08	1	PCS	P3		7B33-016	2	PCS	P30
	7B33-008	4	PCS	P4		7C33-005	2	PCS	P30
	7B33-017	2	PCS	P17					
	7B33-018	2	PCS	P17		NSST120	2.0M		P21
	T04	2	PCS	P21		7C33-S01	2	1980	P29
	Z4.2-38	4	PCS	P21					
	Z3.5-25	8	PCS	P21~24		MCJT002	13M		P20
	M8-35	2	PCS	P22					
	Si8-35	2	PCS	P22		TOOLS	1	PCS	
	Si6-35	4	PCS	P22			1	PCS	
	J05	12	PCS	P22			1	PCS	
	Si6-16	8	PCS	P22			1	PCS	
	Si8-25	3	PCS	P23			1	PCS	
	7C26-031	2	PCS	P23			1	PCS	
	T01	1	PCS	P24					
	T01A	1	PCS	P24					
	J02	2	PCS	P24					
	7B33-049	1	PCS	P24					
	7B33-050	1	PCS	P24					
	7B33-051	1	PCS	P24					
	7B33-052	1	PCS	P24					
	M4-40	2	PCS	P24					
	Mi4-17	2	PCS	P24					
	Za4.2-13	44	PCS	P24~30					
				1d/30					

















SH2GA5-BSC-2

Part	NO.	QTY.	Length(MM)	Page	Part	NO.	QTY.	Length(MM)	Page
	41A-Y30	7	1335	P7		7B33-005	26	PCS	P2~8
	41X-Y31A-L	2	196	P7		Ma8-20	76	PCS	P2~8
	41X-Y31A-R	2	196	P7		M8	76	PCS	P2~8
	41X-Y31L	2	412	P7		Si8-16	52	PCS	P3~10
	41X-Y31R	2	412	P7		7B33-020	52	PCS	P3~10
	51X-Y31A-L	2	846	P7		7B33-013R	6	PCS	P7
	51X-Y31A-R	2	846	P7		7B33-013L	6	PCS	P7
	41X-Y01	7	1335	P12		M8-20	24	PCS	P7
	41X-Y04A-R	2	196	P14~15		J12	57	PCS	P11~15
	41X-Y04A-L	2	196	P14~15					
	41X-Y04R	2	412	P14~15		L13	4	1344	P4
	41X-Y04L	2	412	P14~15		L14	4	1380	P4
	51X-Y04A-R	2	846	P14~15		L16	4	2181	P8
	51X-Y04A-L	2	846	P14~15					
	TOOL-010	1	330						
	TOOL-011	1	455						
	TOOL-012	1	393.6						

SH2GA5-EXTN-2

























Part	NO.	QTY.	Length(MM)	Page	Part	NO.	QTY.	Length(MM)	Page
	41A-Y30	2	1335	P7		7B33-005	8	PCS	P2~8
	51A-Y33-B	2	2148	P8		Ma8-20	16	PCS	P2~8
	41X-Y01	2	1335	P12		M8	16	PCS	P2~8
	41X-Y102	4	480	P17		Si8-16	16	PCS	P3~10
	51X-Y06	2	2216	P17		7B33-020	16	PCS	P3~10
						J12	12	PCS	P17
						7B33-019	2	PCS	P17











SH2GA5-EXTW-2

Part	NO.	QTY.	Length(MM)	Page	Part	NO.	QTY.	Length(MM)	Page
	41A-Y30	2	1335	P7		7B33-005	6	PCS	P2~8
	51A-Y33-C	2	1266	P8		Ma8-20	12	PCS	P2~8
	41A-Y34A	2	951	P8		M8	12	PCS	P2~8
	41X-Y01	2	1335	P12		Si8-16	12	PCS	P3~10
	51X-Y06A	2	1334	P17		7B33-020	12	PCS	P3~10
	41X-Y102	4	480	P17		M8-20	4	PCS	P8
	41X-Y82-A	2	1087	P25		7C33-001	4	PCS	P8
						J12	12	PCS	P17
						7B33-019	2	PCS	P17

NO.	QTY.		
	3731	3732	3733
SH2GA5-BSC-2	1	1	1
SH2GA5-EXTN-2	3	3	4
SH2GA5-EXTW-2	1	2	2

Spare Part Bag For Green Room Season Wall

Part	NO.	QTY.	Length(MM)	Page	Part	NO.	QTY.	Length(MM)	Page
	J09	2	PCS	P2		M8-35	2	PCS	P22
	M8-20	6	PCS	P3~8		Si8-35	2	PCS	P22
	Si8-16	10	PCS	P3~10		Si6-35	2	PCS	P22
	7B33-020	10	PCS	P3~10		J05	2	PCS	P22
	7C33-001	4	PCS	P3~8		Si6-16	2	PCS	P22
	7C28-004	4	PCS	P9~23		Si8-25	2	PCS	P23
	Z4.2-13	4	PCS	P9~21		7C26-031	2	PCS	P23
	J12	8	PCS	P11~25		M4-40	2	PCS	P24
	Z4.2-50	4	PCS	P18~23		Mi4-17	2	PCS	P24
	W04	4	PCS	P19~25		Za4.2-13	4	PCS	P24~30
	Z4.2-38	2	PCS	P21		T07	2	PCS	P26
	Z3.5-25	2	PCS	P21~24		Z4.8-25	2	PCS	P29

Part	NO.	QTY.			Length(MM)	Page
		3731	3732	3733		
	354×1369	16	16	16	1369	P11
	479×1369	16	20	24	1369	P11
	318×206	4	4	4	318	P14~15
	354×423	4	4	4	423	P14~15
	354×643	4	4	4	643	P14~15
	354×856	4	4	4	856	P14~15
	354×1076	4	4	4	1076	P14~15
	479×2234	12	12	16	2234	P17
	479×1343	4	8	8	1343	P17
	664×1844	2	2	2	1844	P19
	1032×831	2	4	4	1032	P25

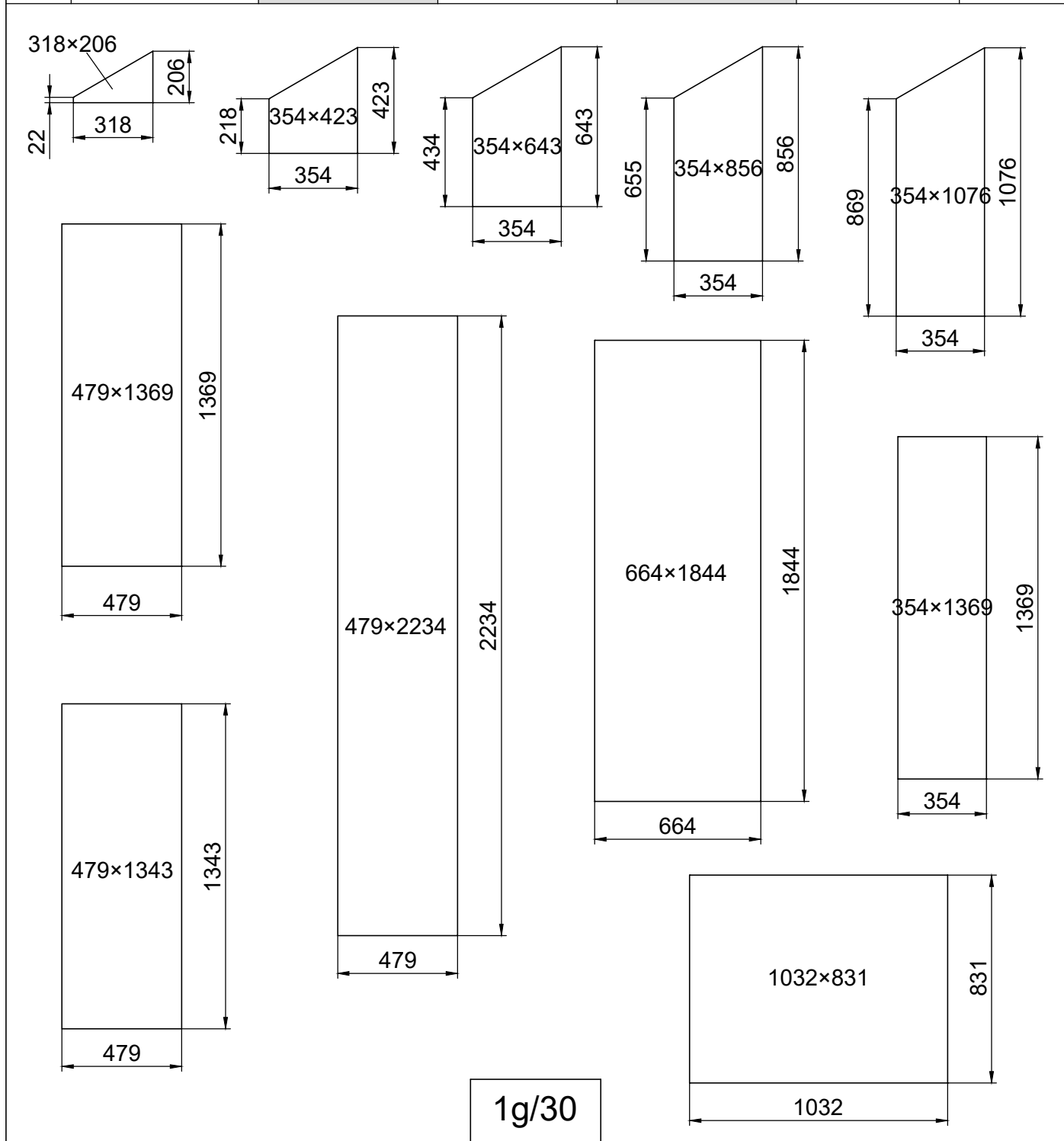

Code	Length(MM)		
		3731	3732
L	4205	5206	6207

Sealing should be done to prevent frost from destroying the wall. The sealant between the wall and foundation of the greenroom is provided and handled by customers themselves.

Tätning bör göras för att muren ej skall frostsprängas. Tätning mellan mur och sockel står kunden själv för.

Tætningen bør gøres for at forhindre frostsprængninger i muren. Tætningen mellem mur og aluminiumprofil står kunden selv for

En tetning bør lages for å hindre frostsprengning av muren. Tetning mellom mur og sokkel ordnes av kunden selv

Tiivistys täytyy tehdä, jotta muuri ei hajoa pakkasella. Tiiviste muurin ja sokkelin välissä täytyy asiakkaan hoitaa itse

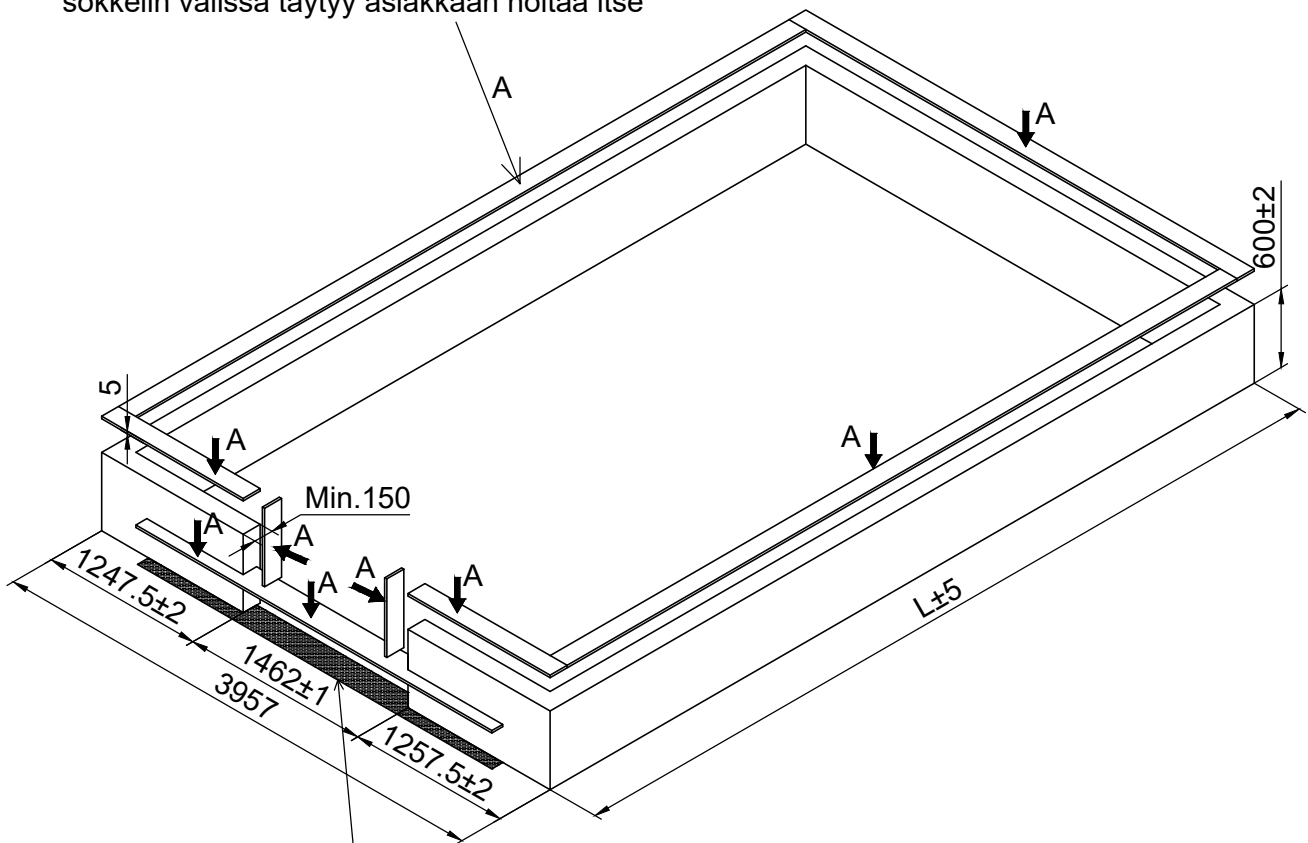

Make sure the floor below the doors frame should be flat and solid.
 Se till att underlaget under dörrramen är plan och på solid grund.
 Sørg for, at underlaget under dørkarmen er plan og på fast grund.
 Sørg for at underlaget under dørterskelen er slett og på solid fundament.
 Tarkista, että maa ovikarmin alla on sileä ja tasainen.

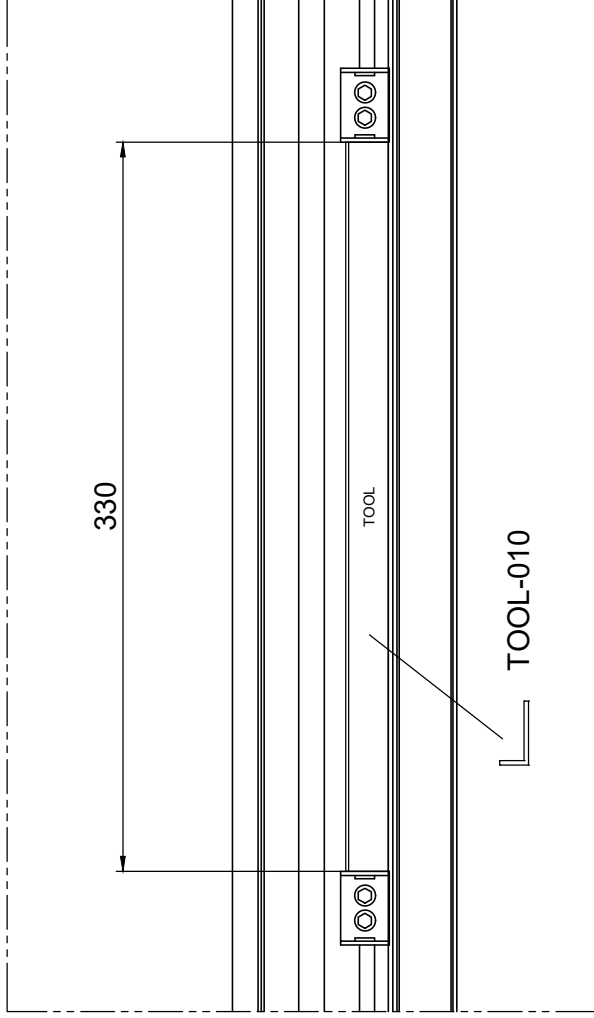

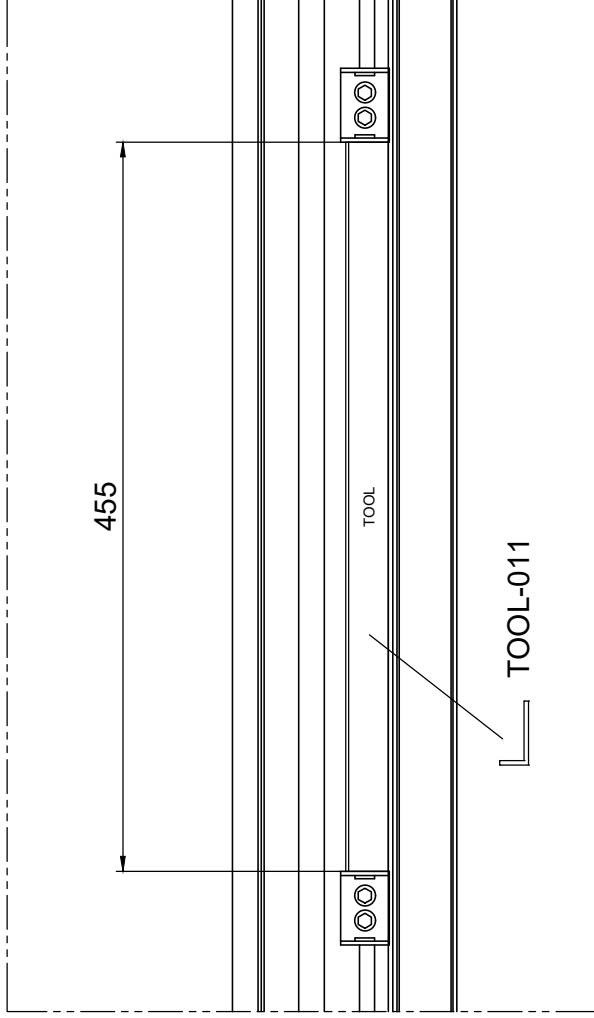

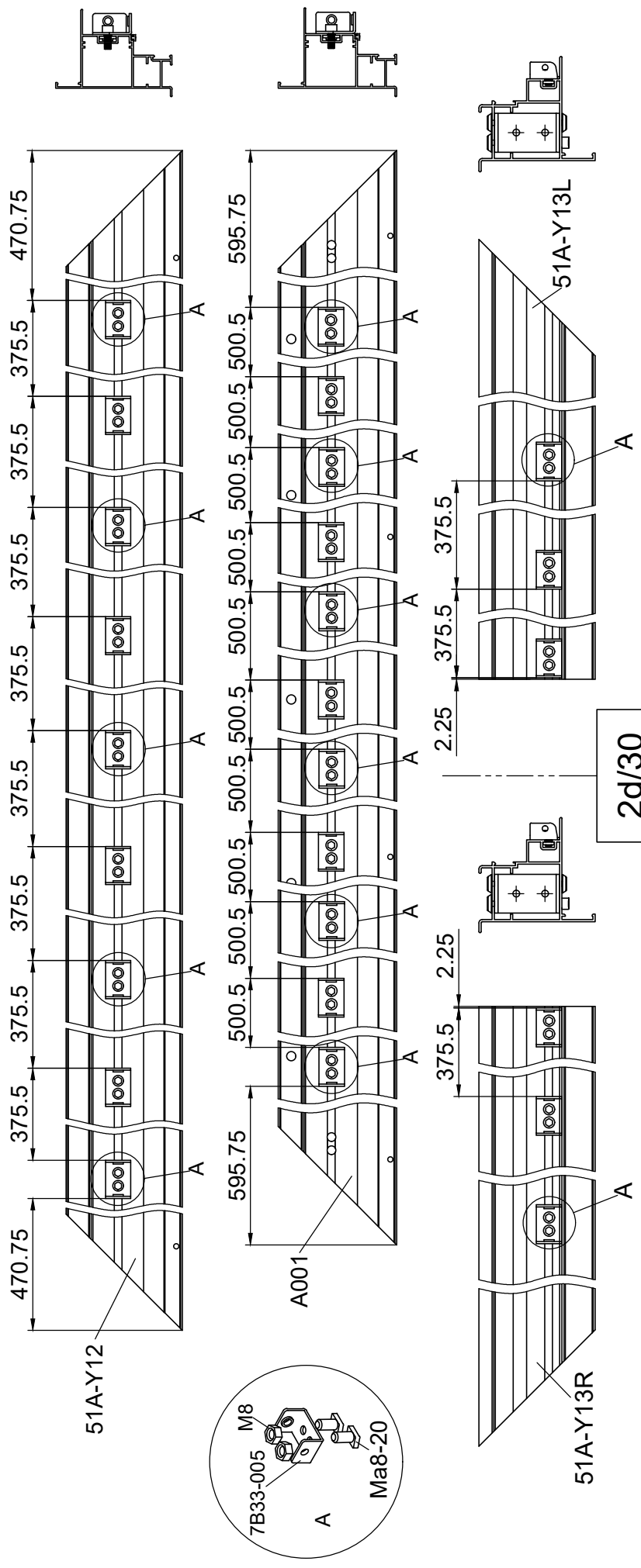

Part	NO.	QTY.	Length(MM)	QTY.								Length (MM)		
				3731		3732		3733		3733				
				SH2GA5-BSC-2	SH2GA5-EXTN-2	SH2GA5-BSC-2	SH2GA5-EXTN-2	SH2GA5-BSC-2	SH2GA5-EXTN-2	SH2GA5-BSC-2	SH2GA5-EXTN-2	SH2GA5-BSC-2	SH2GA5-EXTN-2	
	7B33-005	7	6	2	7	4	4	4	4	7	8	4	4	PCS
	Ma8-20	14	12	4	14	12	8	12	8	14	16	8	8	PCS
	M8	14	12	4	14	12	8	12	8	14	16	8	8	PCS

Part	Product	NO.	Length (MM)	QTY.	Code
	3731	41A-Y11-4	4239		
	3732	41A-Y11-5	5240	2	A001
	3733	41A-Y11-6	6241		



Part	NO.	QTY.	Length(MM)
	7B33-001	4	PCS
	W03	4	30

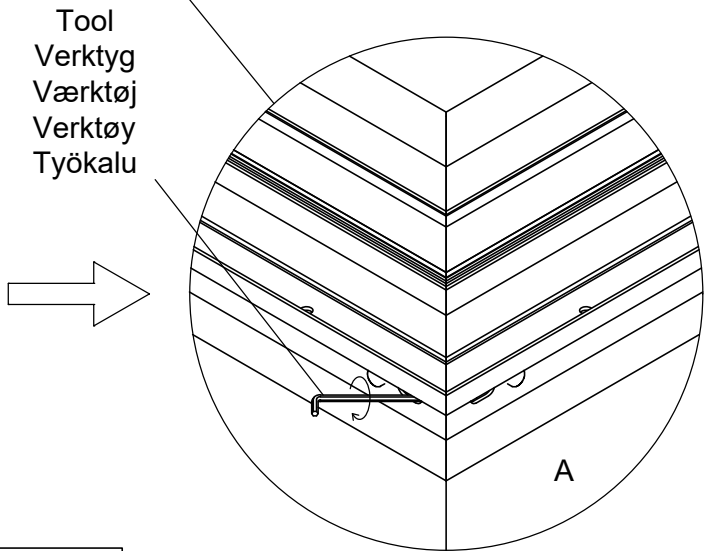
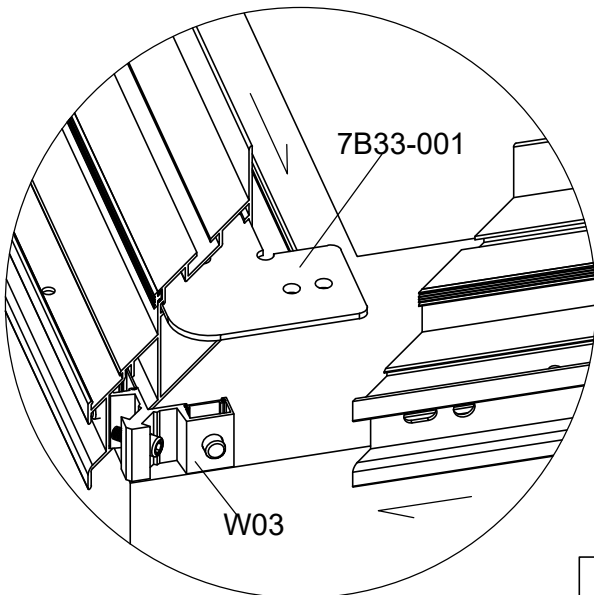
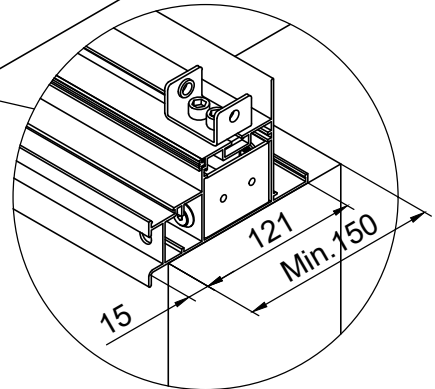
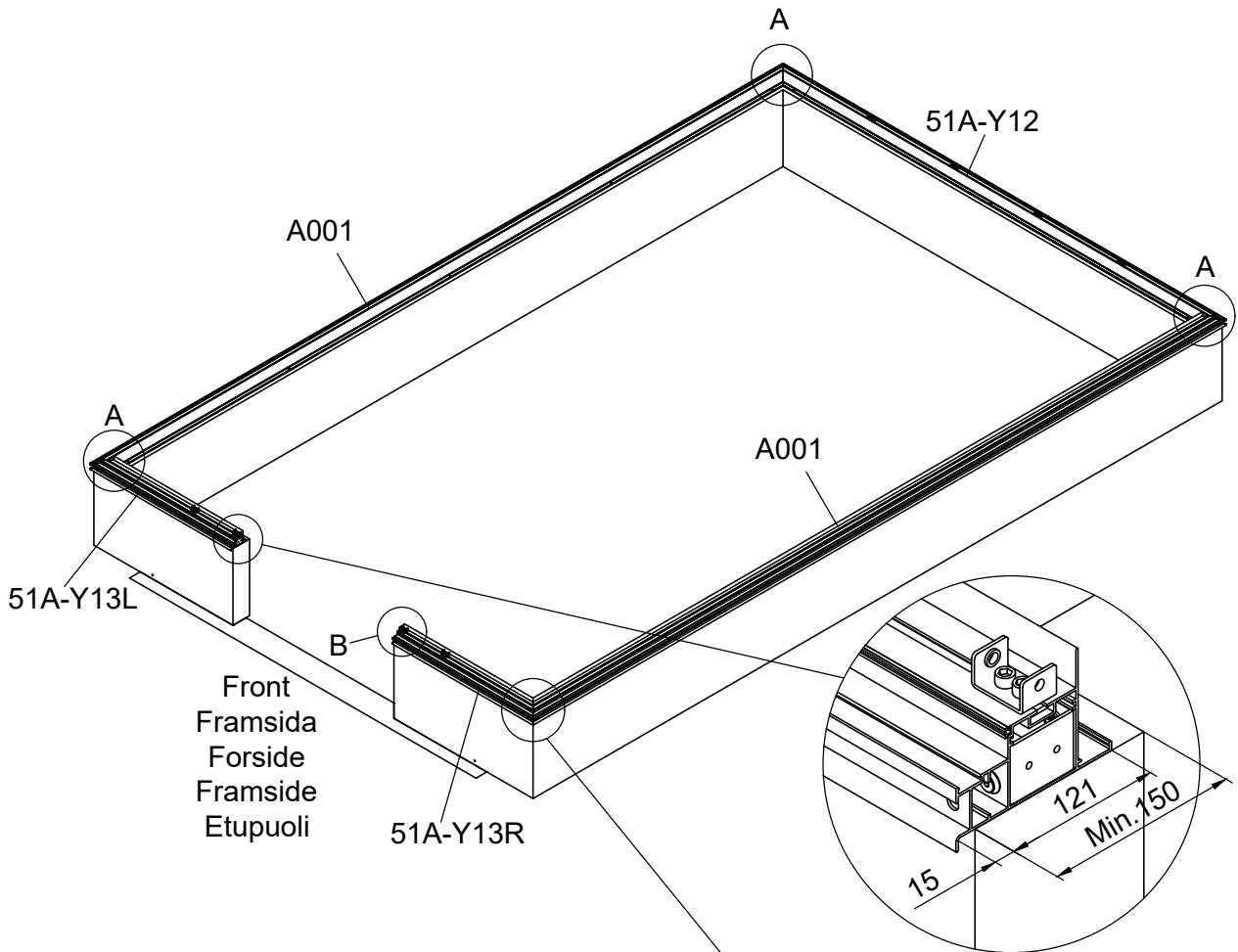

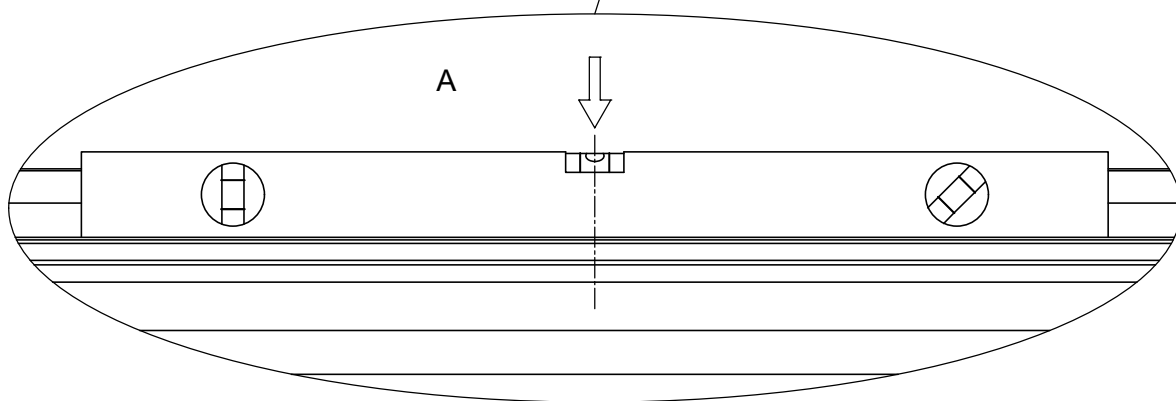
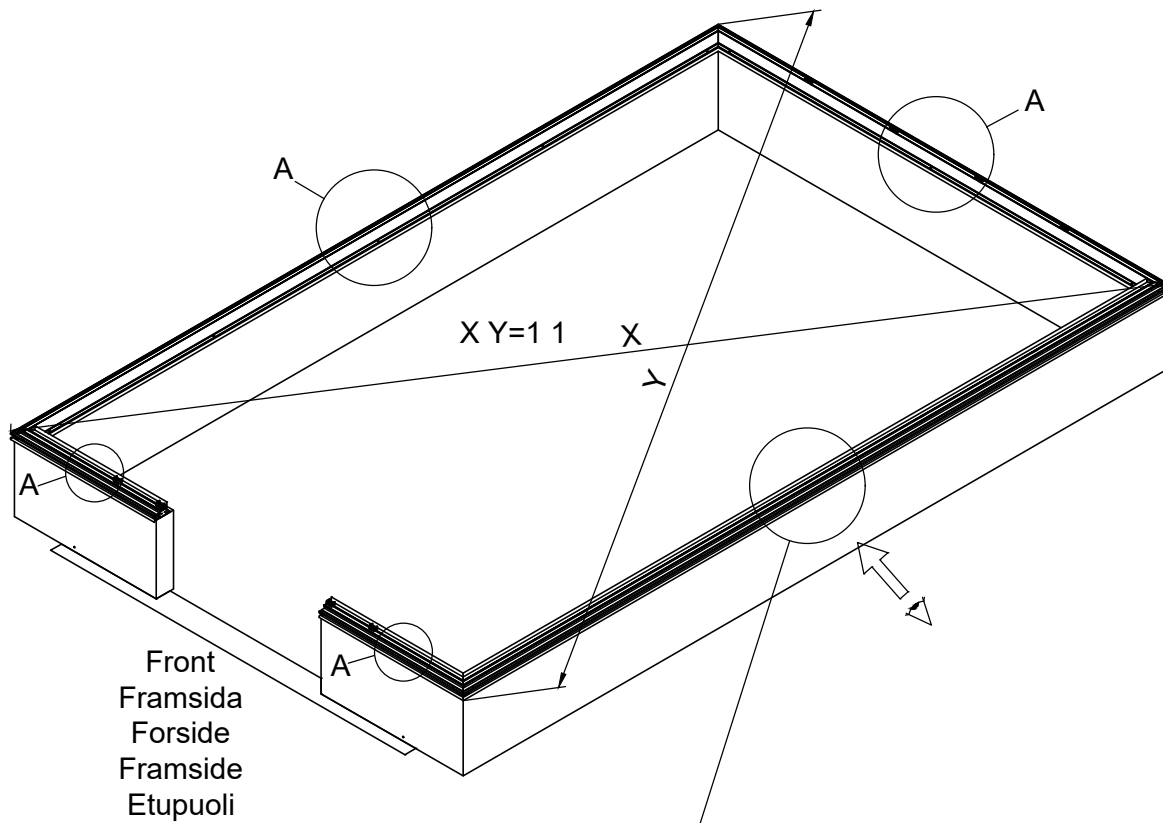



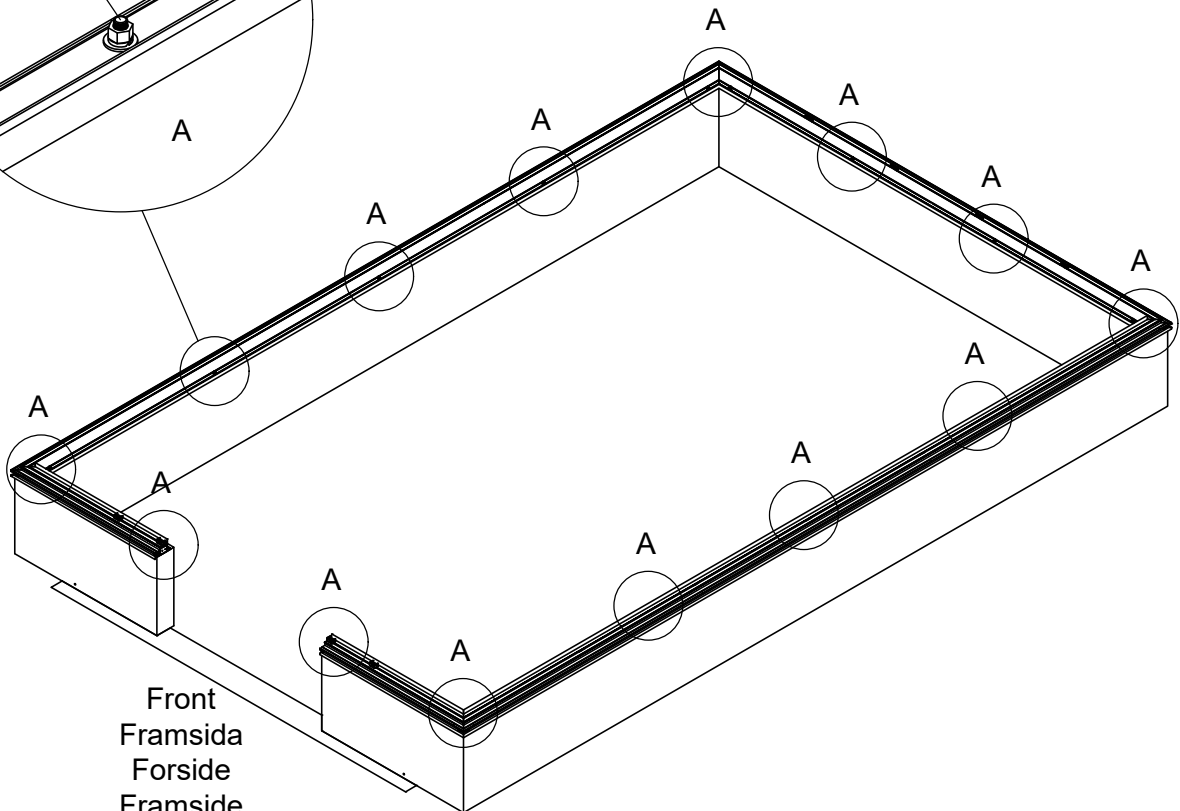
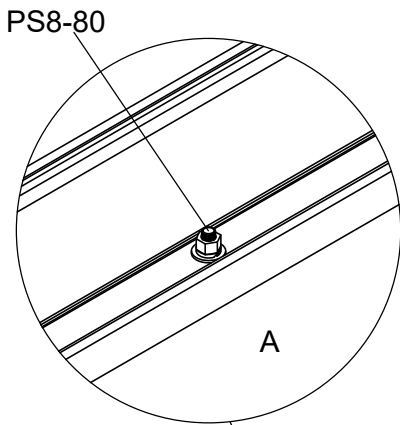
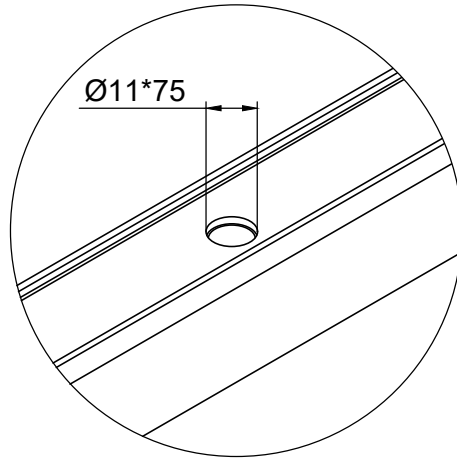
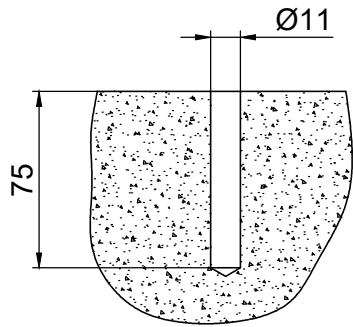

Part	NO.	QTY.	Length(MM)
	PS8-80	18	PCS





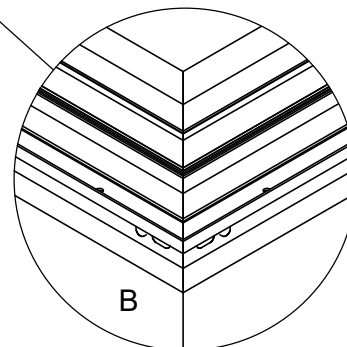
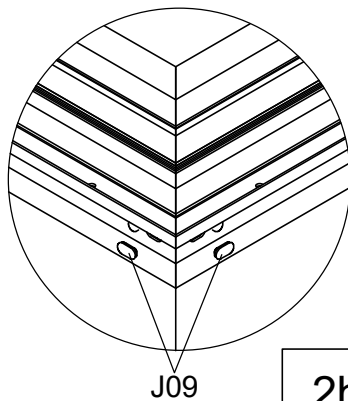
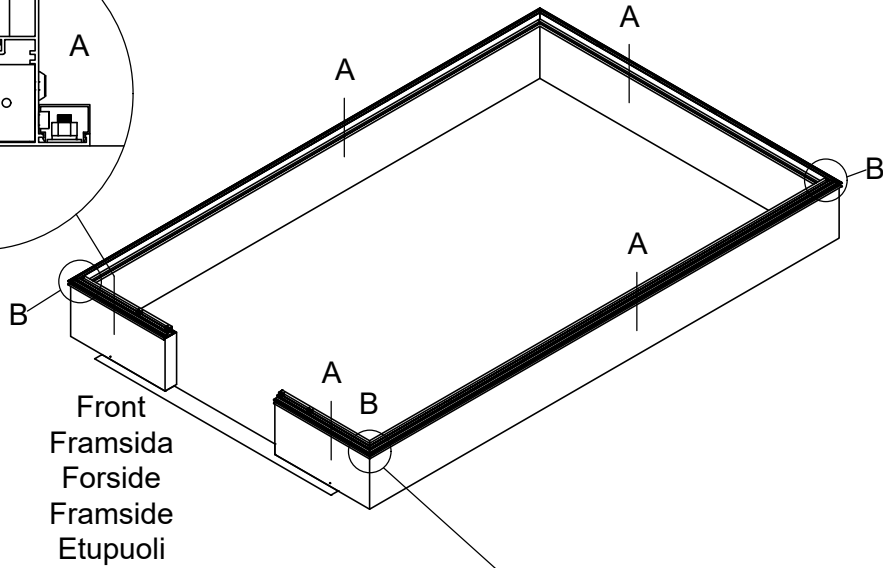
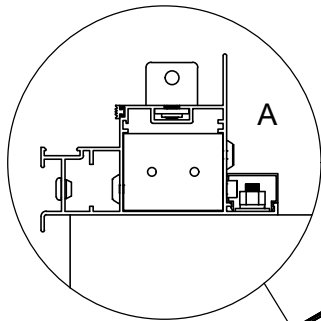
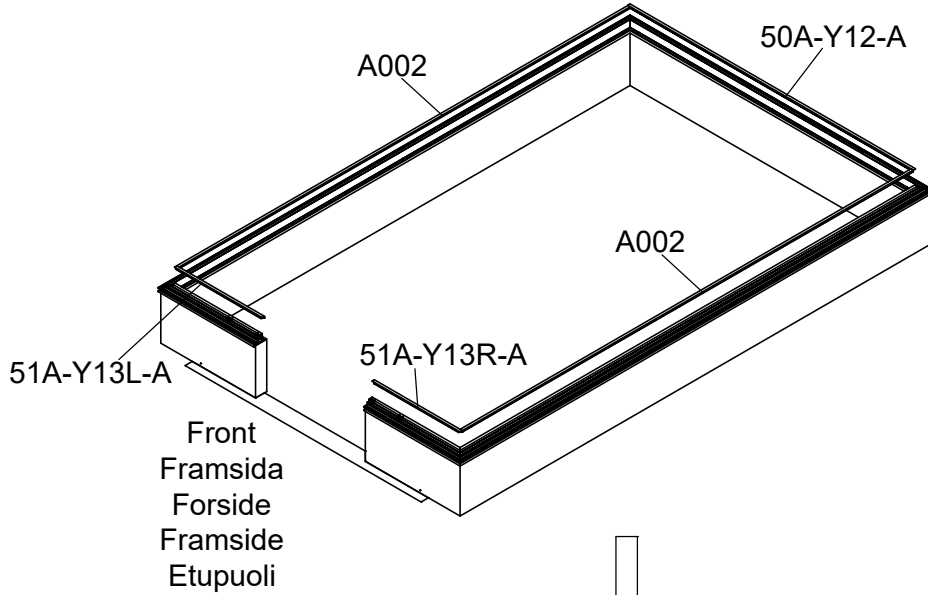

Front
 Framsida
 Forside
 Framside
 Etupuoli

Part	NO.	QTY.	Length(MM)
	50A-Y12-A	1	3773
	51A-Y13R-A	1	1161
	51A-Y13L-A	1	1161
	J09	8	PCS





Part	Product	NO.	Length(MM)	QTY.	Code
	3731	41A-Y11-4A	3962	2	A002
	3732	41A-Y11-5A	4963		
	3733	41A-Y11-6A	5964		

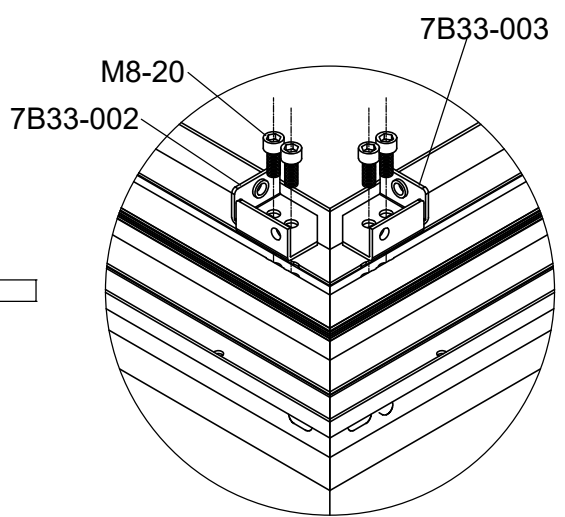
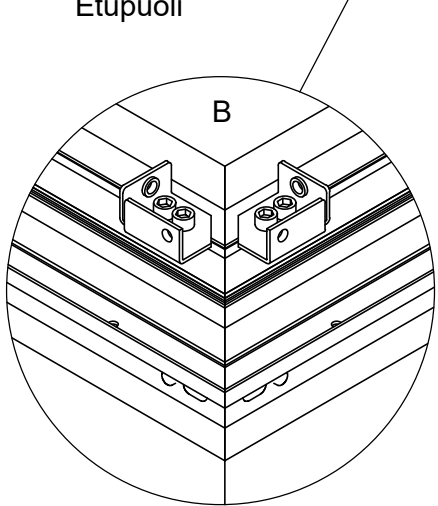
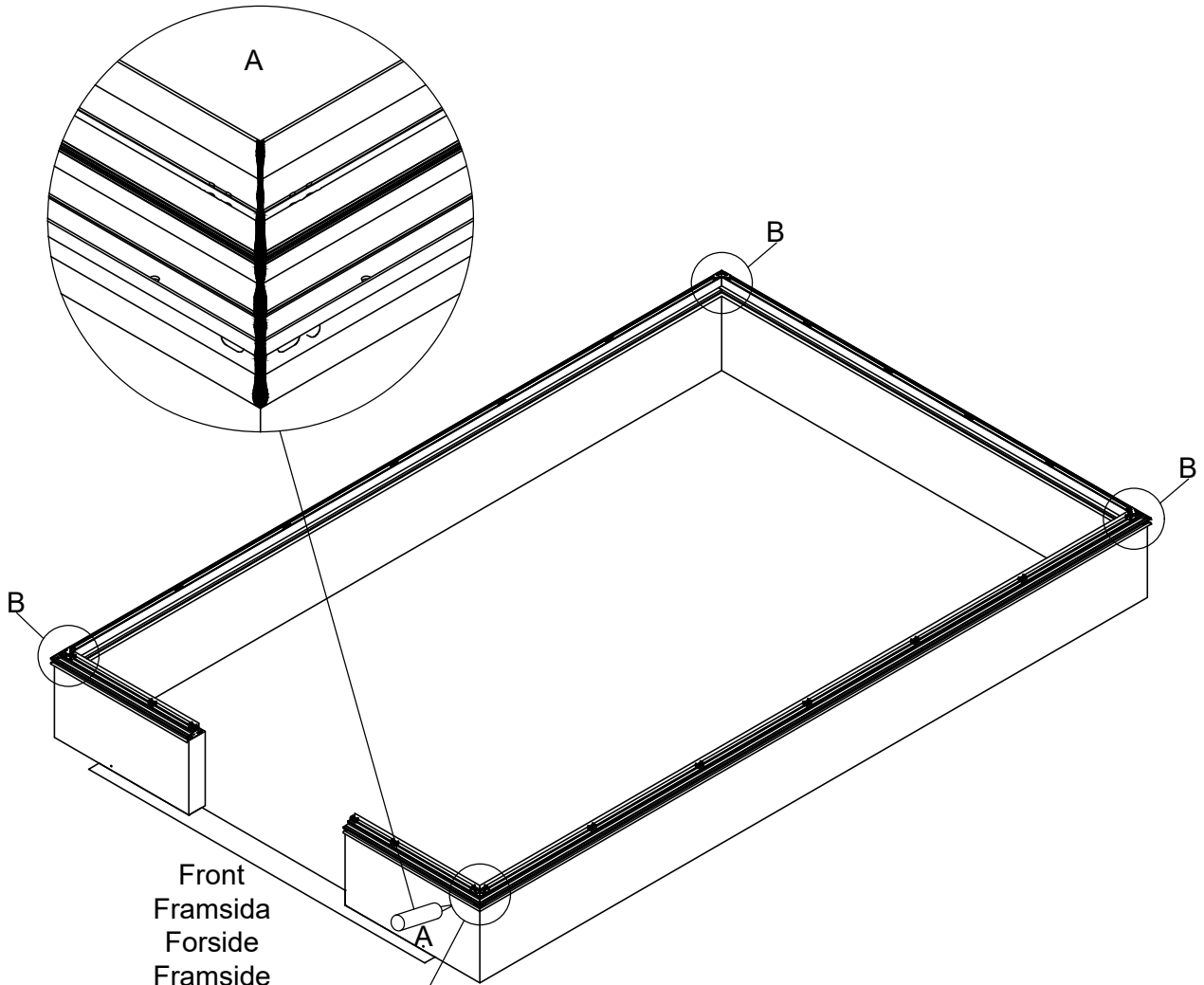

2h/30

Part	NO.	QTY.	Length(MM)
	7B33-002	4	PCS
	7B33-003	4	PCS
	M8-20	16	PCS
	J08	1	PCS



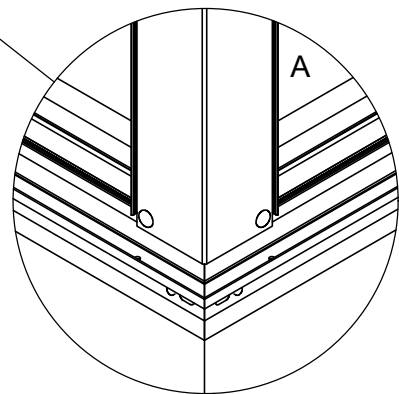
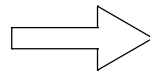
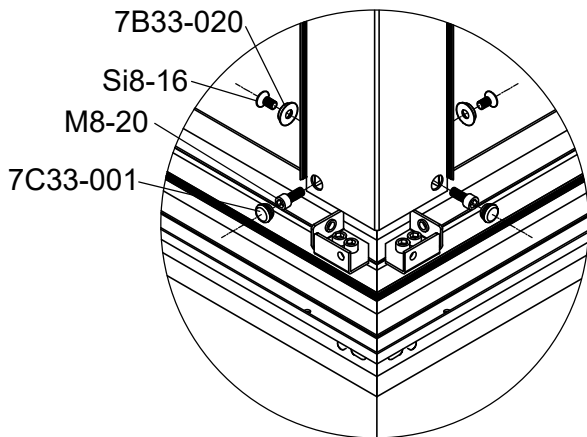
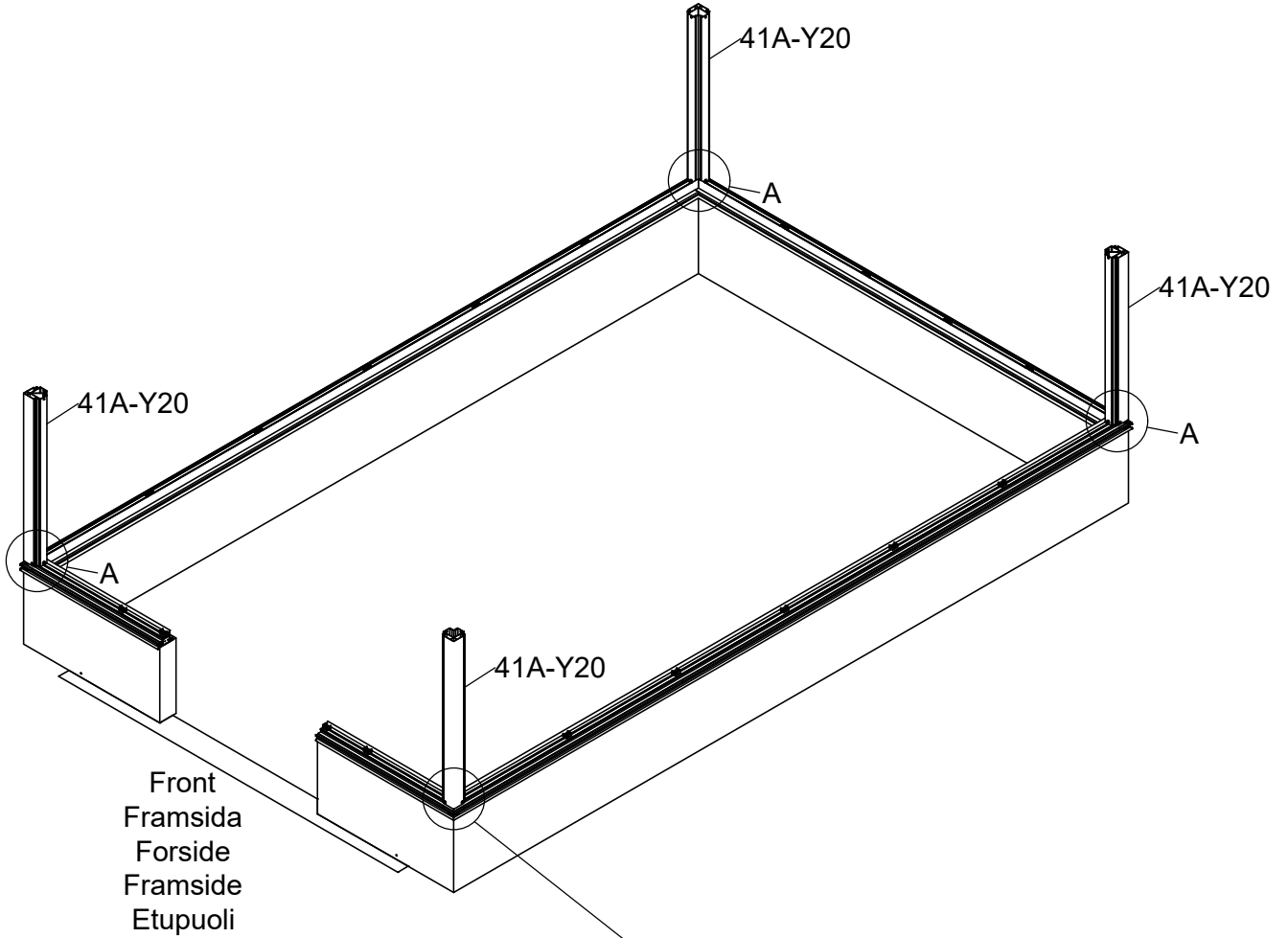

Part	NO.	QTY.	Length(MM)
	41A-Y20	4	1336
	Si8-16	8	PCS
	7B33-020	8	PCS
	M8-20	8	PCS
	7C33-001	8	PCS



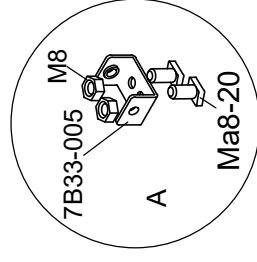
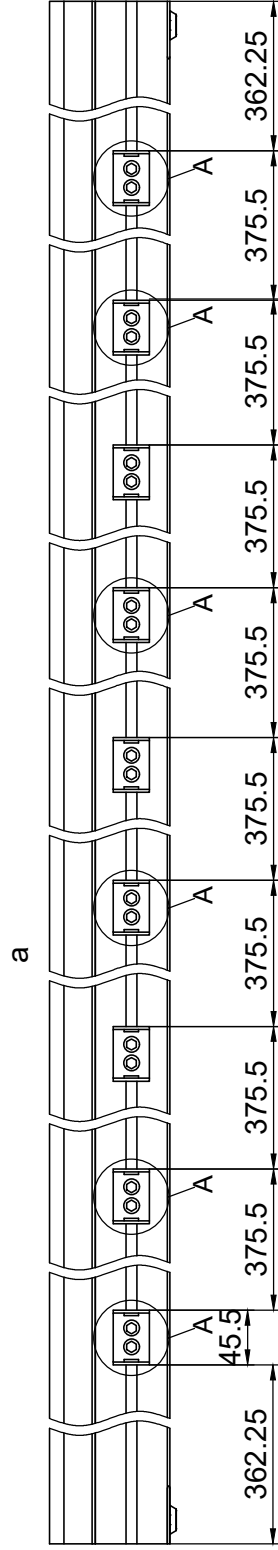
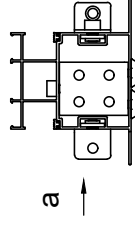
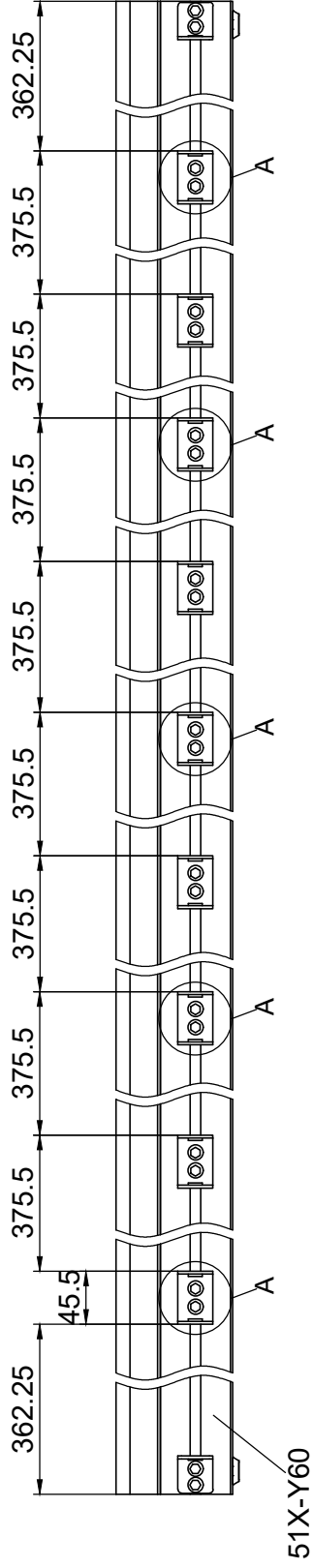

Part	NO.	QTY.	Length(MM)
	51X-Y60	1	3774
	7B33-005	11	PCS
	Ma8-20	22	PCS
	M8	22	PCS



Part	NO.	QTY.	Length(MM)	CTN NO.
	7B33-005	11	PCS	SH2GA5-BSC-2
	Ma8-20	22	PCS	SH2GA5-BSC-2
	M8	22	PCS	SH2GA5-BSC-2



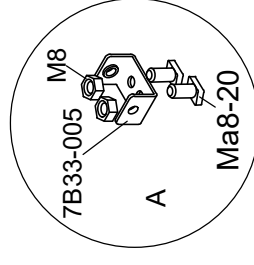
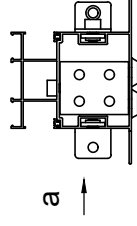
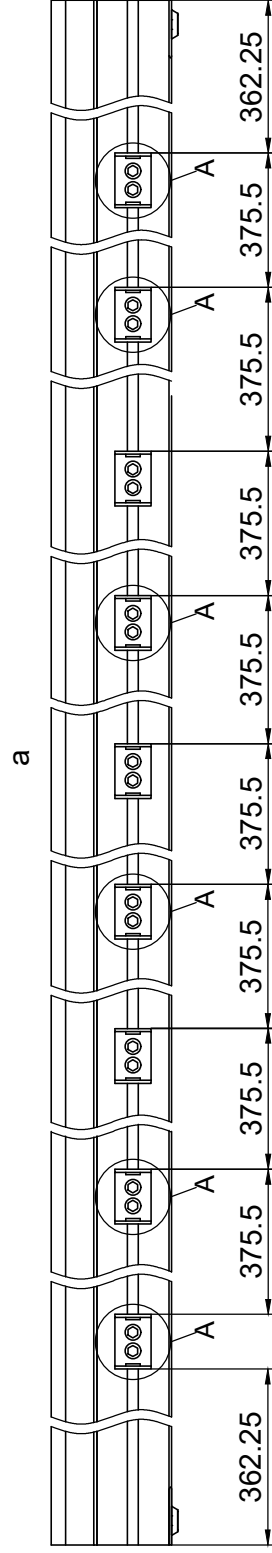
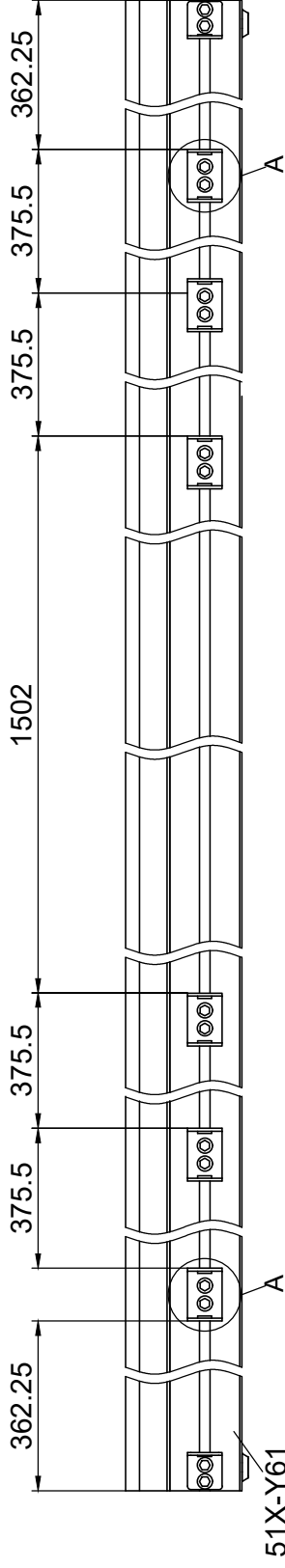

Part	NO.	QTY.	Length(MM)
	51X-Y61	1	3774

Part	NO.	QTY.	Length(MM)	CTN NO.
	7B33-005	8	PCS	SH2GA5-BSC-2
	Ma8-20	16	PCS	SH2GA5-BSC-2
	M8	16	PCS	SH2GA5-BSC-2



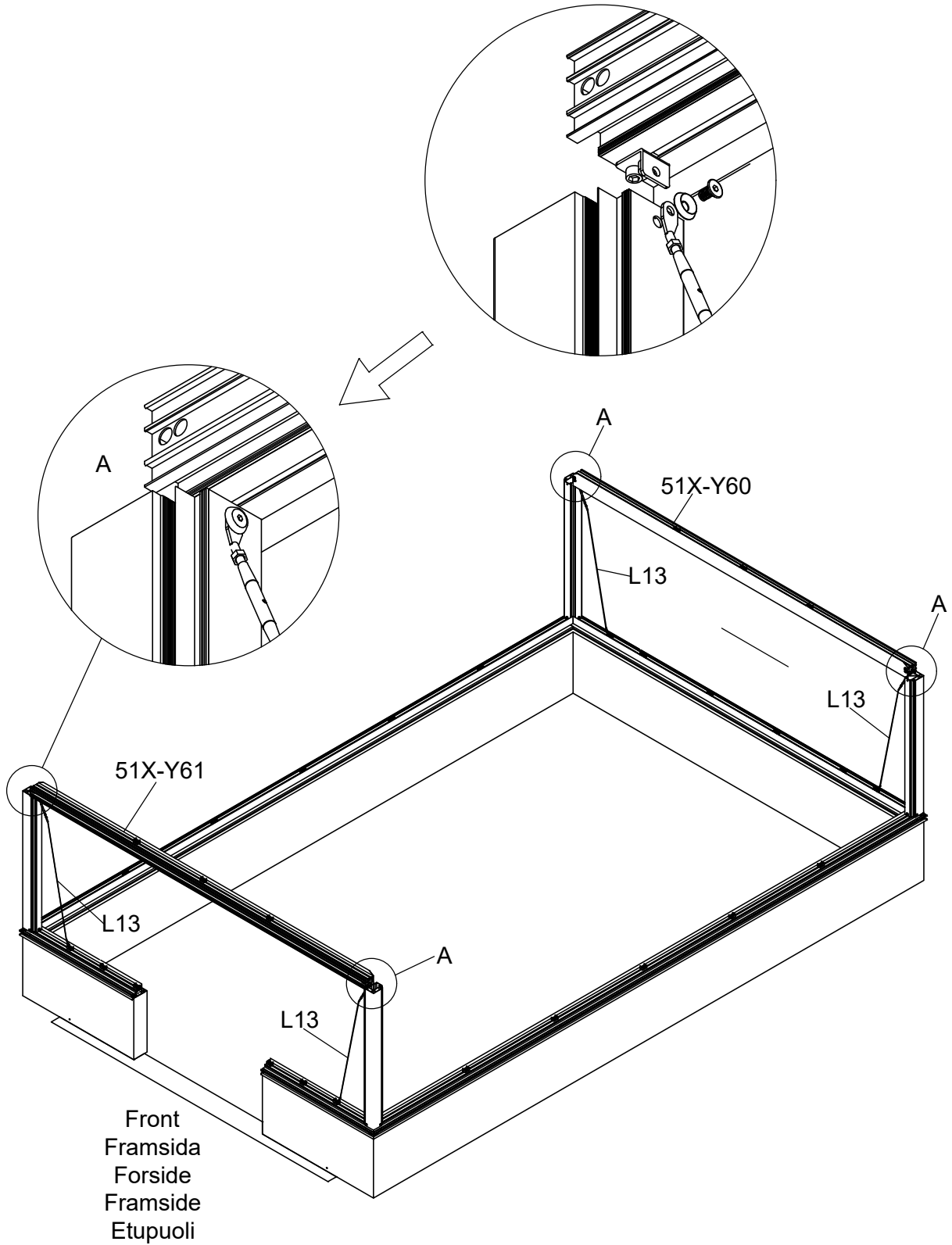

Part	NO.	QTY.	Length(MM)
	SI8-16	4	PCS
	7B33-020	4	PCS
	L13	4	1344



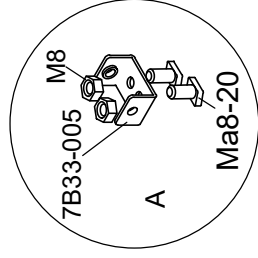
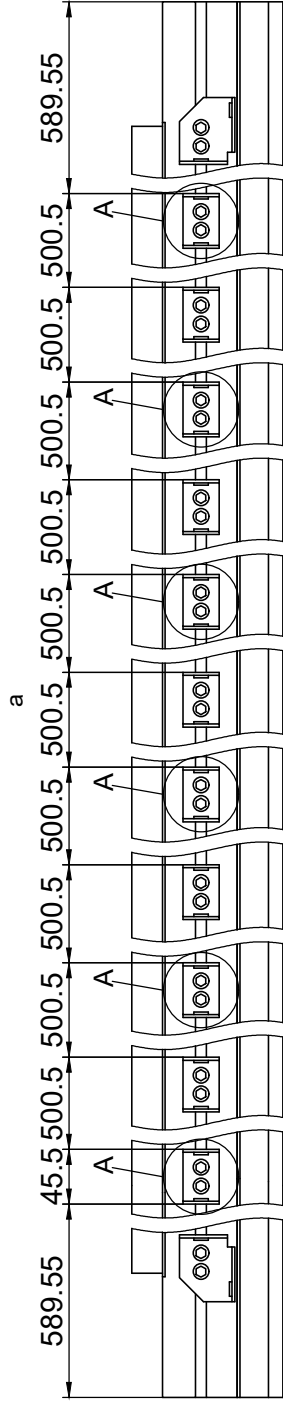
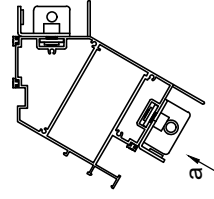
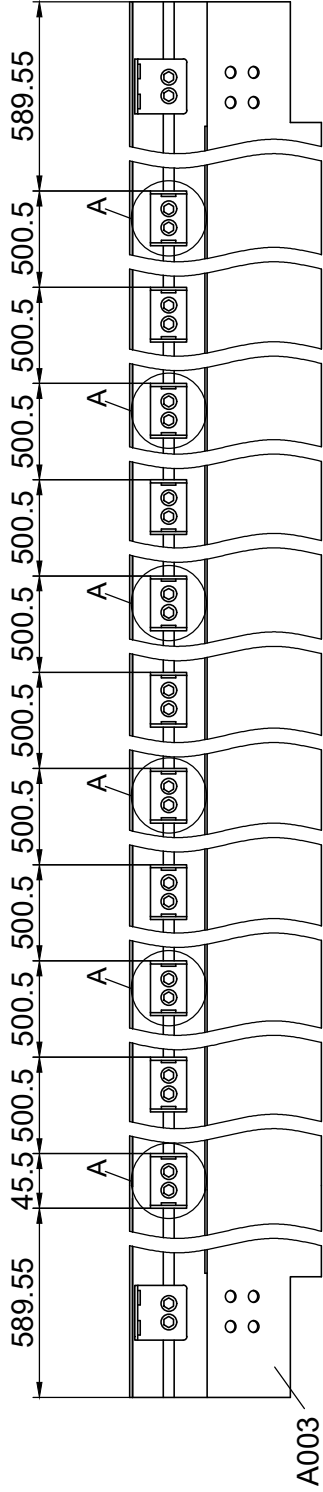

Part	Product	NO.	Length(MM)	QTY.	Code	QTY.				Length (MM)	
						3731	3732	3733			
	3731	41X-Y62-4	4228	2	A003	SH2GA5-EXTN-2	SH2GA5-EXTW-2	SH2GA5-EXTN-2	SH2GA5-EXTW-2	8	
	3732	41X-Y62-5	5229			12	4	12	8	16	8
	3733	41X-Y62-6	6230			24	8	24	16	32	16
						7B33-005				16	
						Ma8-20				16	
						M8				16	



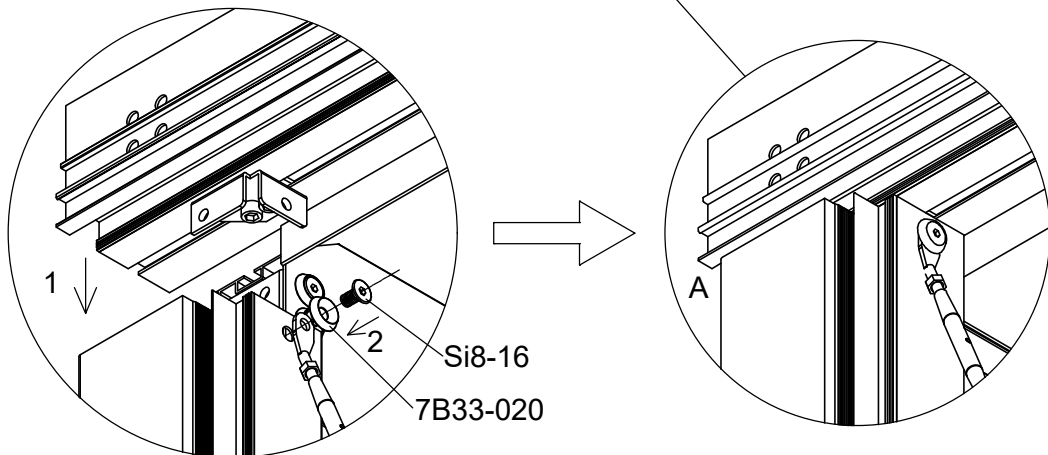
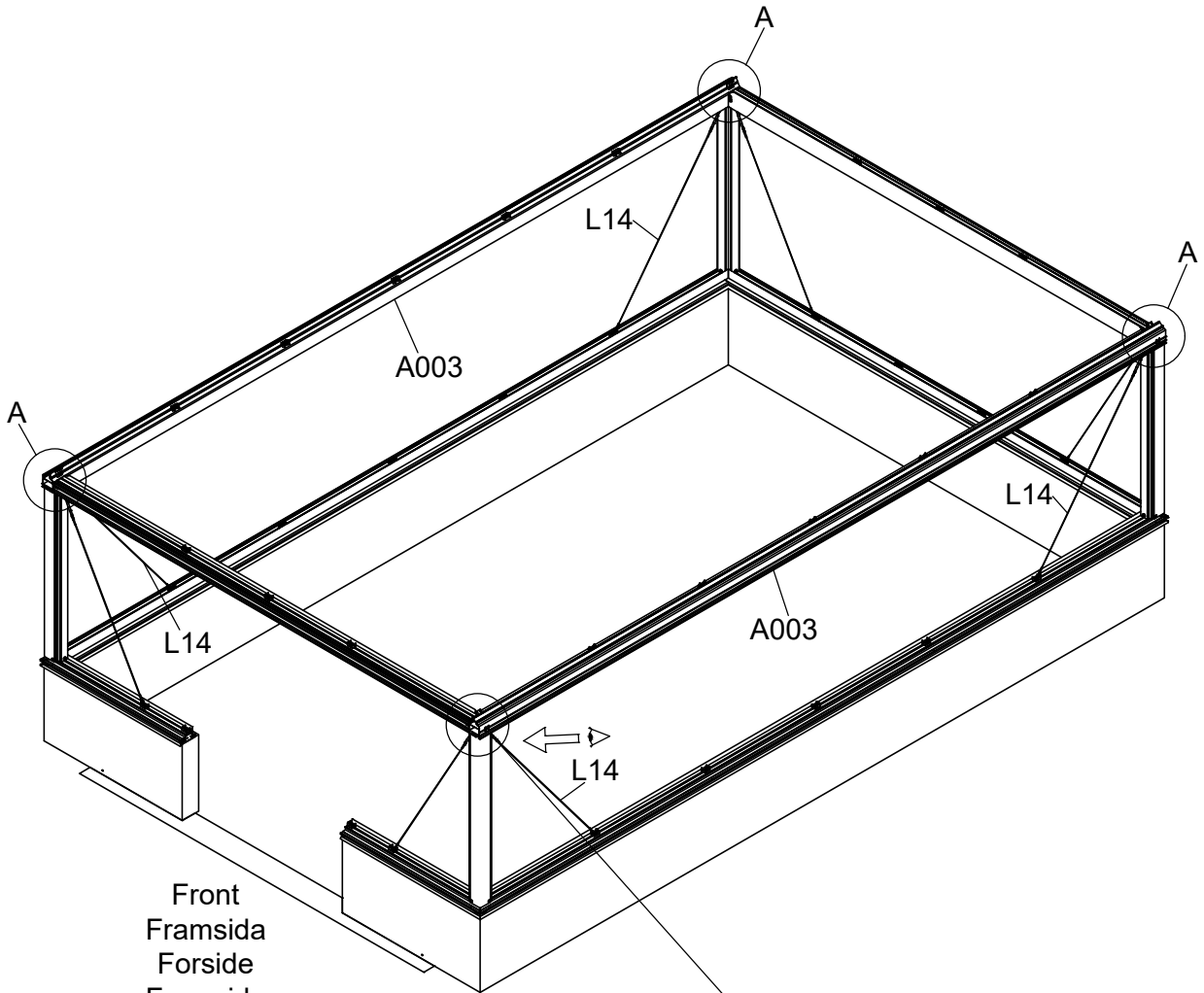

Part	NO.	QTY.	Length(MM)
	Si8-16	4	PCS
	7B33-020	4	PCS
	L12	4	1380

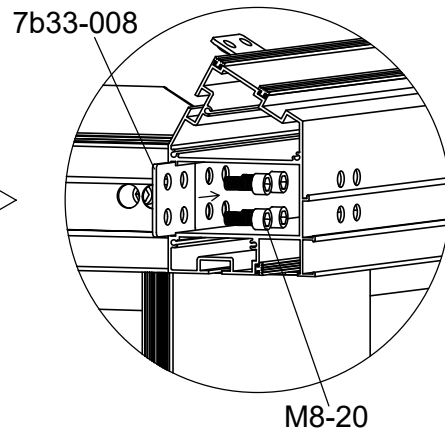
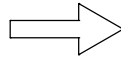
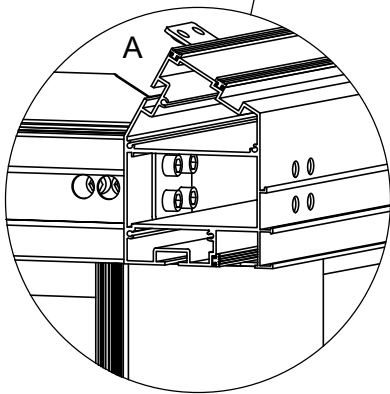
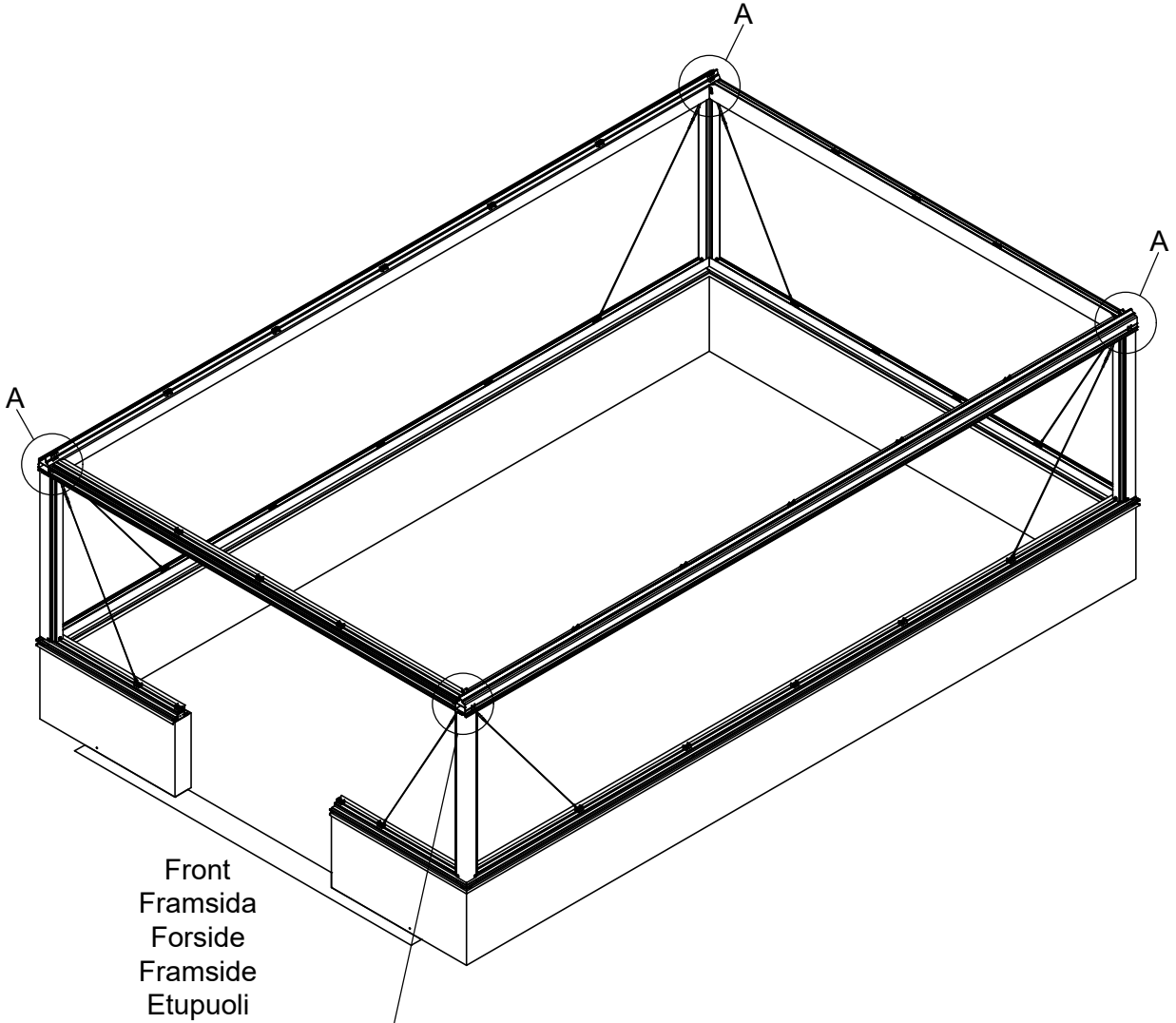

Part	NO.	QTY.	Length(MM)
	7B33-008	4	PCS
	M8-20	16	PCS



Part	NO.	QTY.		Length (MM)
		SH2GA5-BSC-2	SH2GA5-EXTN-2	
	41A-Y30	4	4	1335
	Si8-16	8	8	PCS
	7B33-020	8	8	PCS

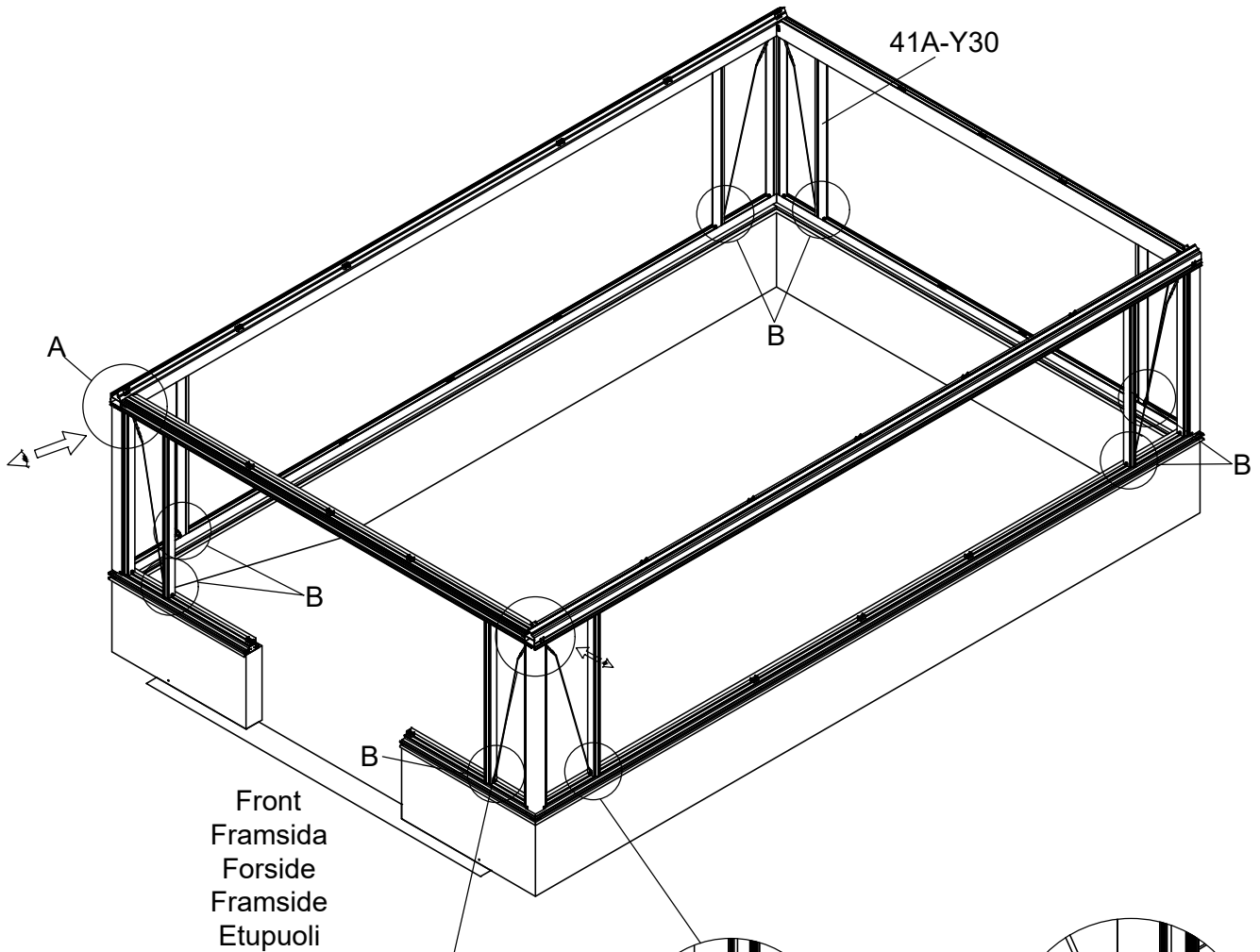

Front
Framsida
Forside
Framsida
Etupuoli

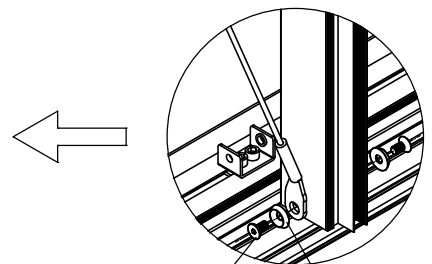
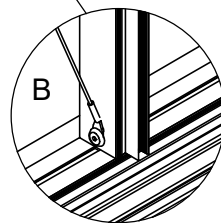

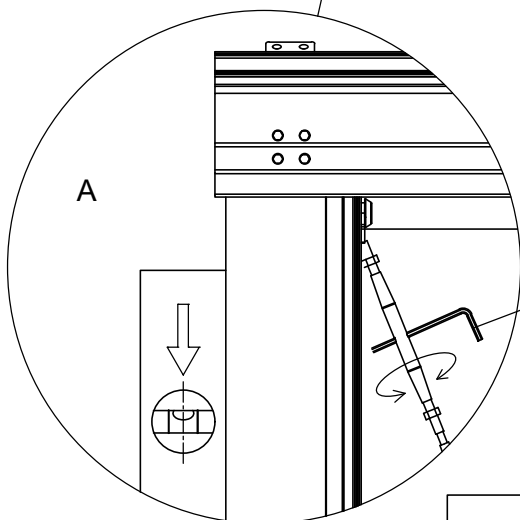

Si8-16

7B33-020



Tool
Verktøj
Værktøj
Verktøy
Työkälu

5a/30

Part	NO.	QTY.												Length (MM)
		3731				3732				3733				
		3731	SH2GA5-BSC-2	SH2GA5-EXTN-2	SH2GA5-EXTW-2	3732	SH2GA5-BSC-2	SH2GA5-EXTN-2	SH2GA5-EXTW-2	3733	SH2GA5-BSC-2	SH2GA5-EXTN-2	SH2GA5-EXTW-2	
	41X-Y30	14	3	2	2	16	3	2	4	18	3	4	4	1335
	Si8-16	52	20	16	8	60	20	16	16	68	20	24	16	PCS
	7B33-020	52	20	16	8	60	20	16	16	68	20	24	16	PCS

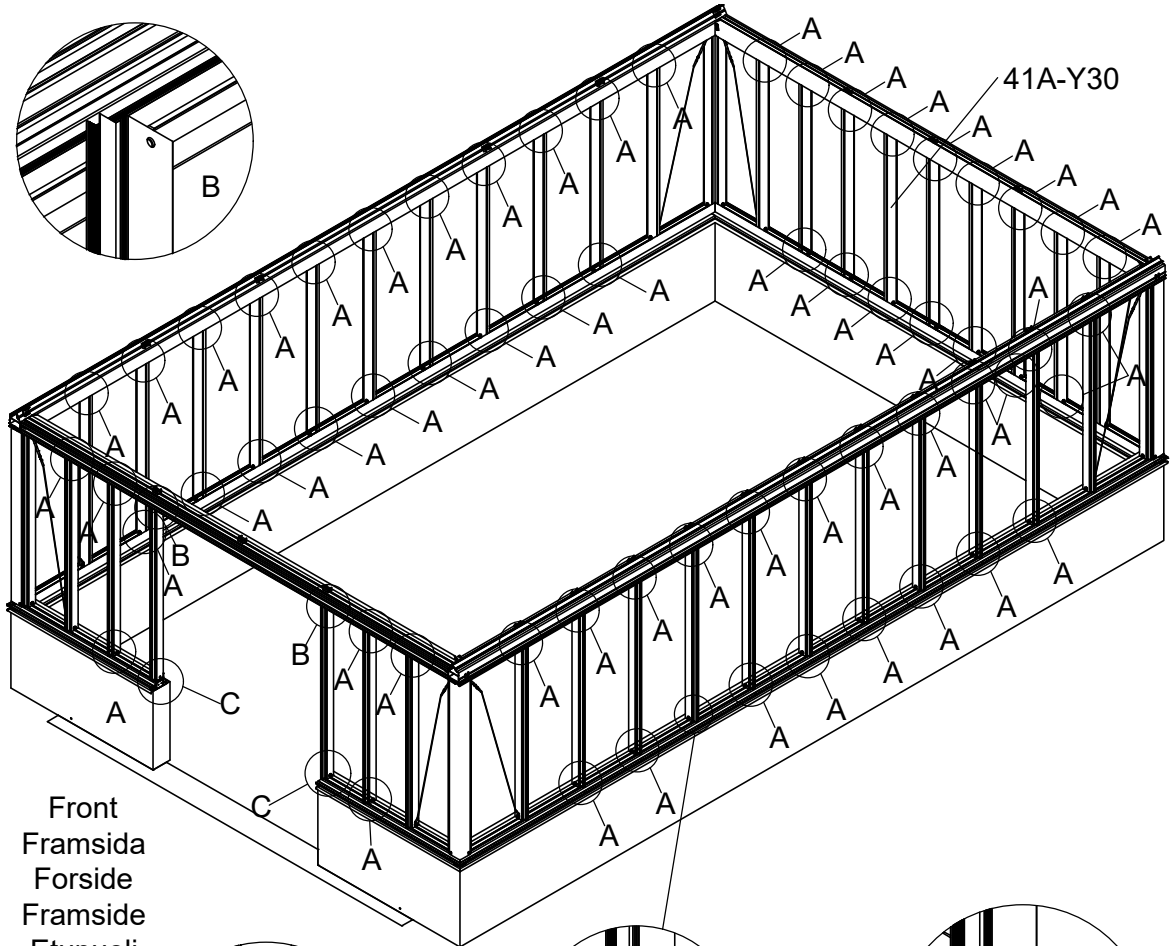

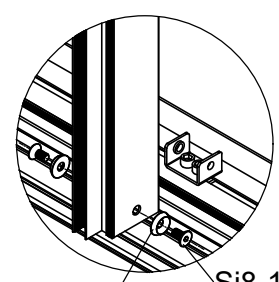
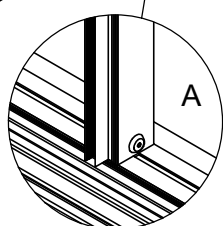
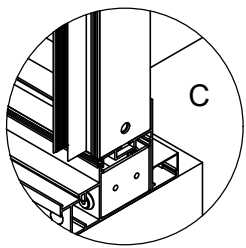

Front
Framsida
Forside
Framsida
Etupuoli



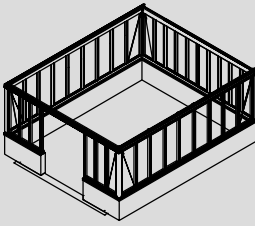
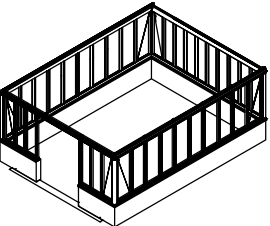
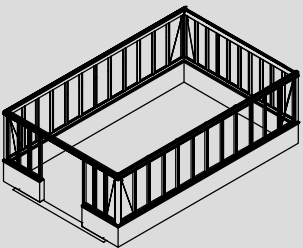

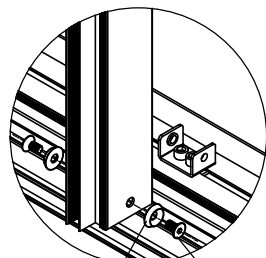
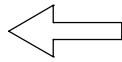
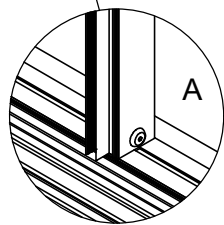
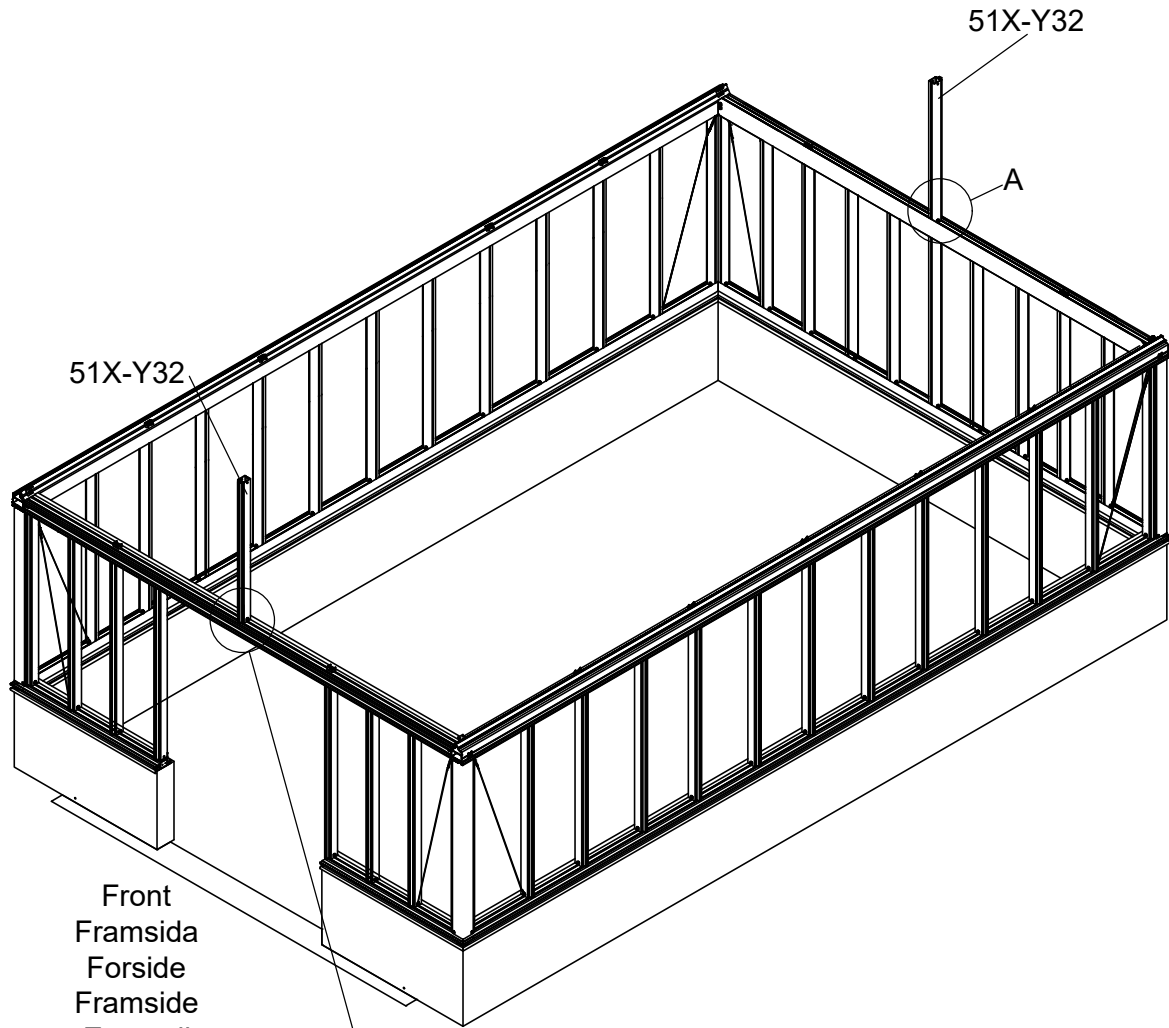

7B33-020 Si8-16

3731	3732	3733
		

Part	NO.	QTY.	Length(MM)
	51X-Y32	2	1074
	Si8-16	4	PCS
	7B33-020	4	PCS



Part	Product	NO.	Length(MM)	QTY.	Code	Part	NO.	QTY.			Length(MM)	CTN NO.
								3731	3732	3733		
	3731	41X-Y63-4	4207	1	A004		7B33-005	6	6	8	PCS	SH2GA5-EXTN-2
	3732	41X-Y63-5	5208				Ma8-20	12	12	16	PCS	SH2GA5-EXTN-2
	3733	41X-Y63-6	6209				M8	12	12	16	PCS	SH2GA5-EXTN-2

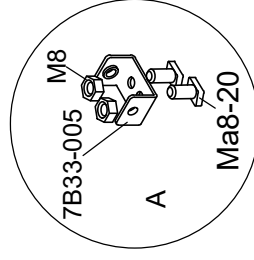
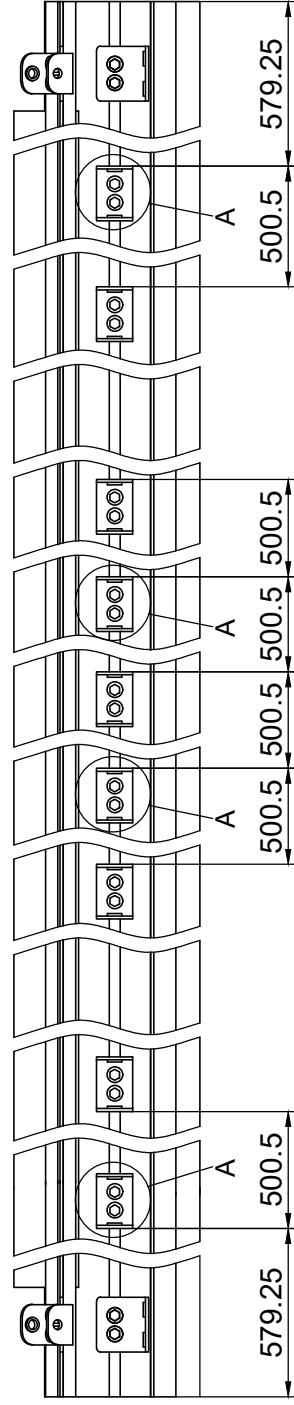
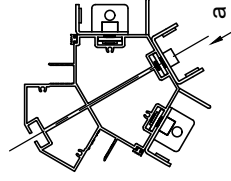
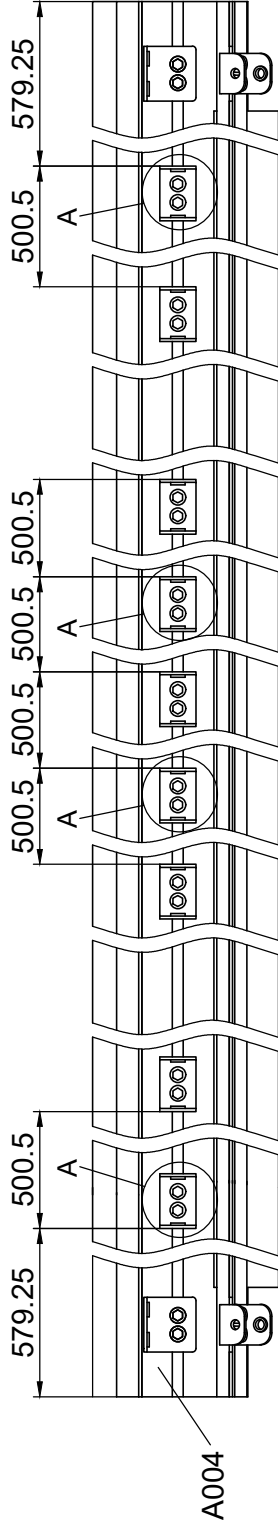

Part	NO.	QTY.	Length(MM)
	M8-20	4	PCS

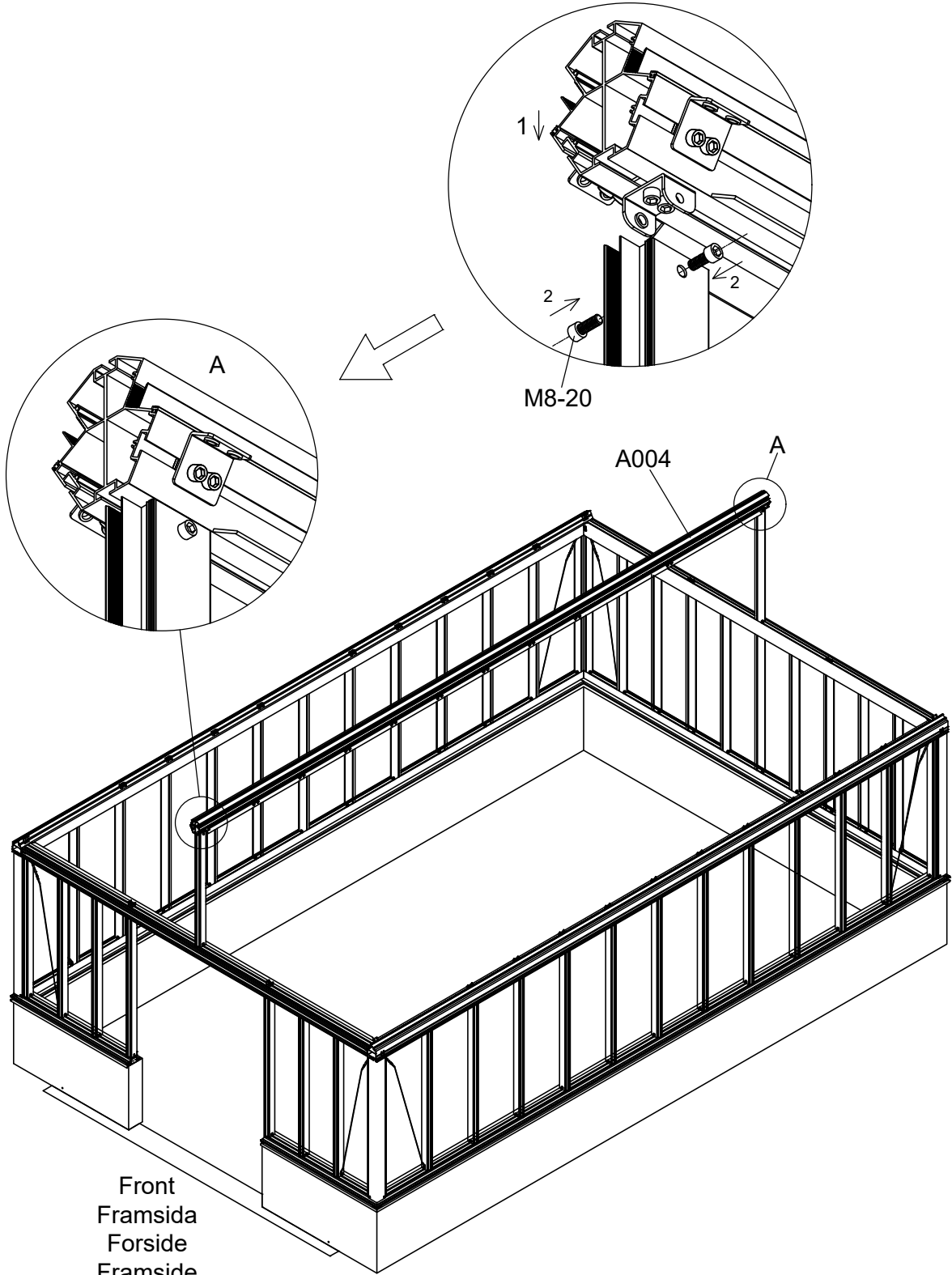



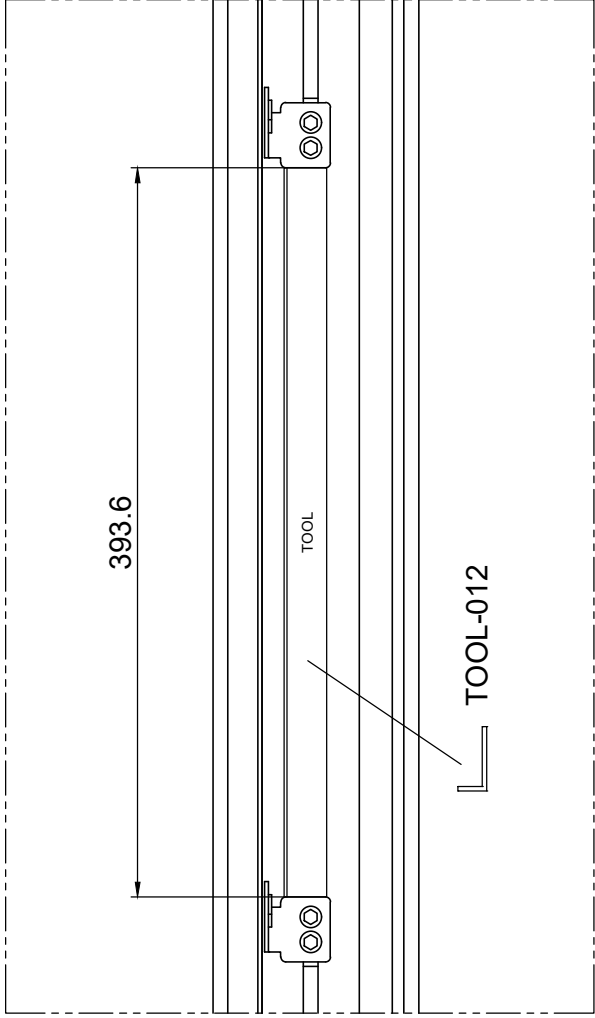

Front
 Framside
 Forside
 Framside
 Etupuoli



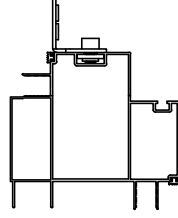
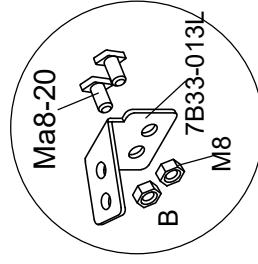
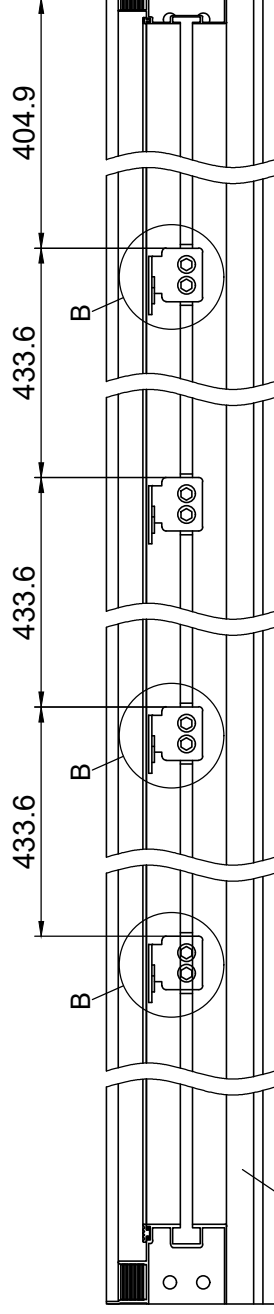
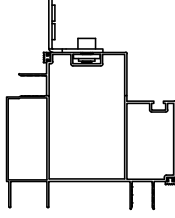
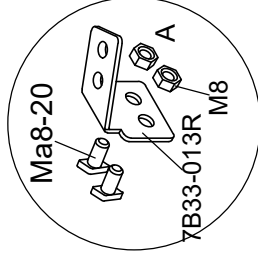
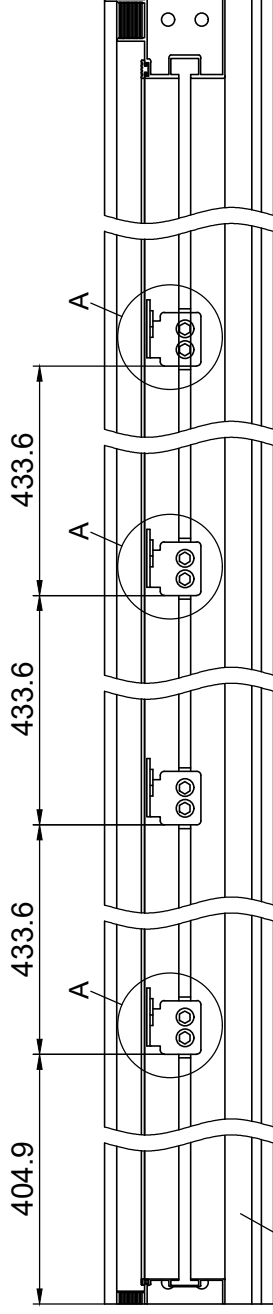



Part	NO.	QTY.	Length(MM)
	51X-Y21	2	2149
	51X-Y22	2	2149



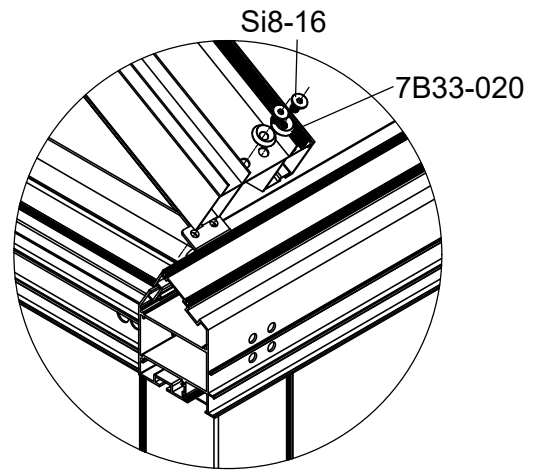
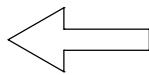
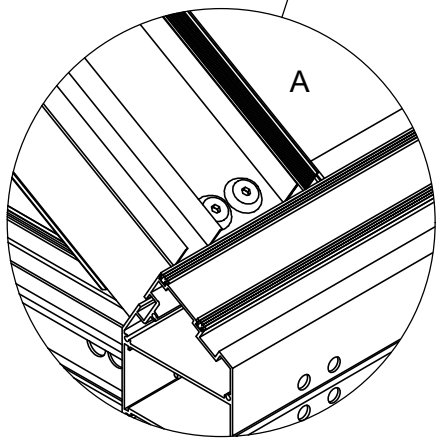
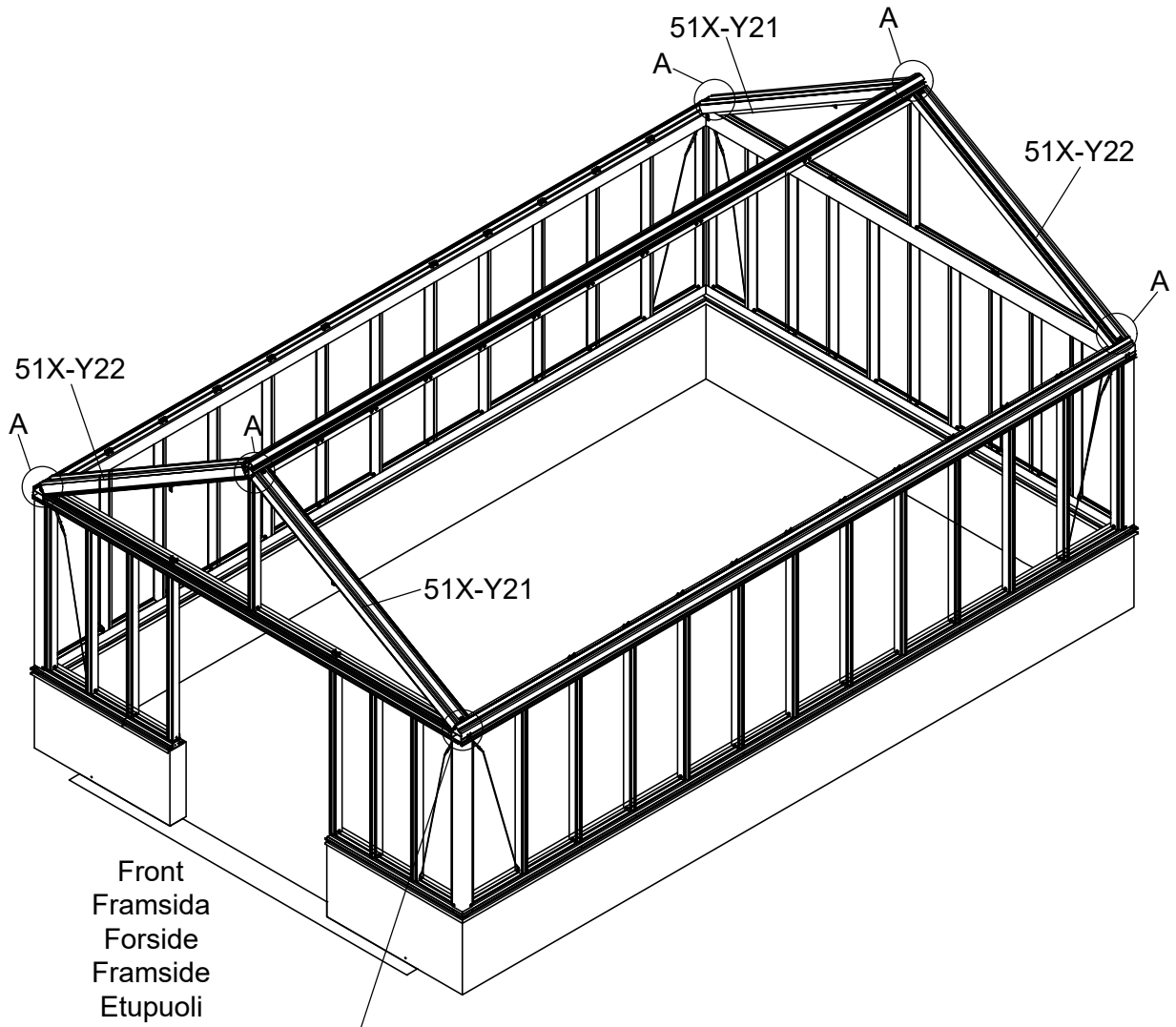





Part	NO.	QTY.	Length(MM)	CTN NO.
	7B33-013R	6	PCS	SH2GA5-BSC-2
	7B33-013L	6	PCS	SH2GA5-BSC-2
	Ma8-20	12	PCS	SH2GA5-BSC-2
	M8	12	PCS	SH2GA5-BSC-2









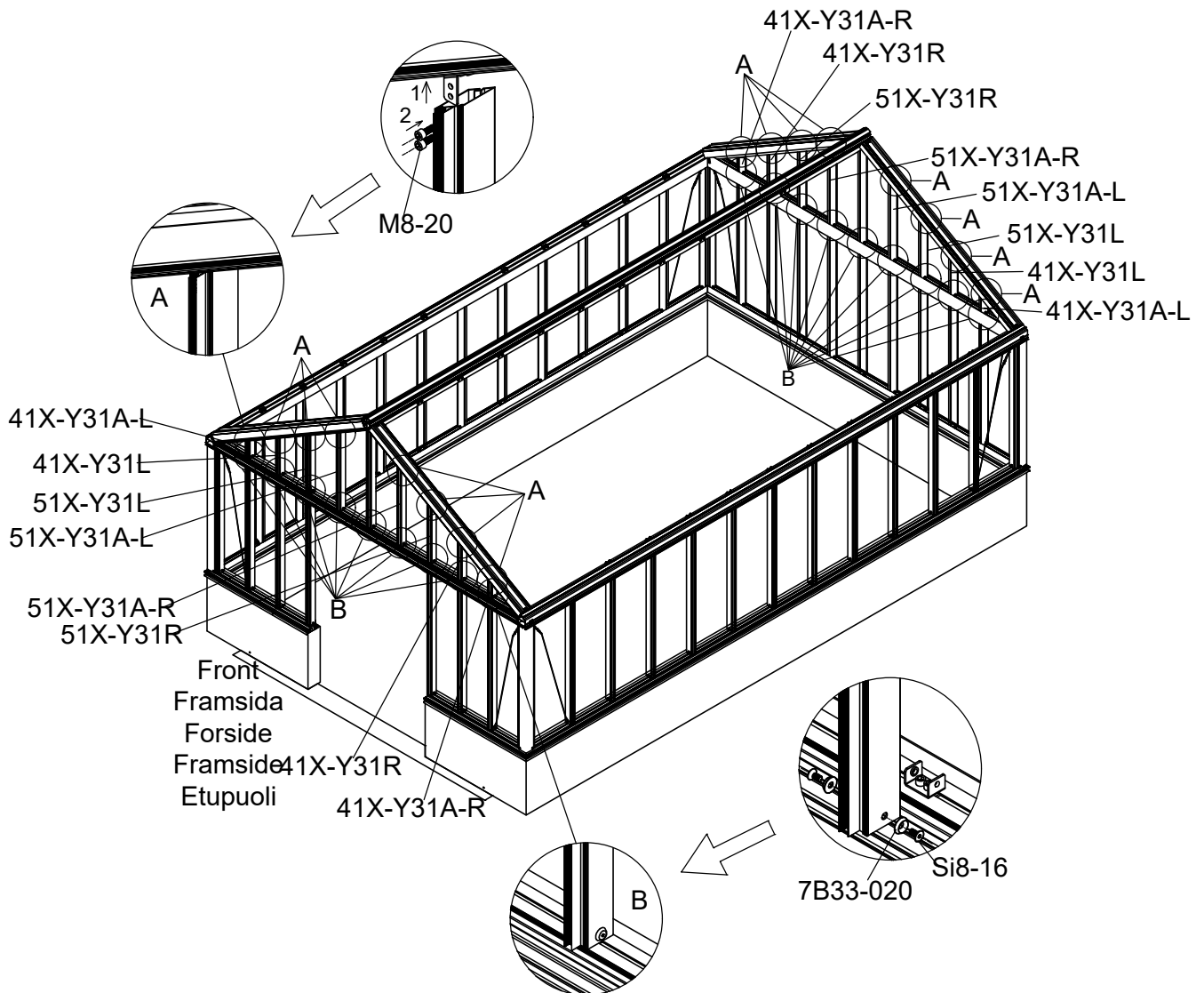

Part	NO.	QTY.	Length(MM)
	51X-Y21	2	2149
	51X-Y22	2	2149
	Si8-16	16	PCS
	7B33-020	16	PCS





Part	NO.	QTY.	Length(MM)
	51X-Y31R	2	629
	51X-Y31L	2	629
	M8-20	8	PCS
	Si8-16	8	PCS
	7B33-020	8	PCS

Part	NO.	QTY.	Length(MM)	CTN NO.
	41X-Y31A-R	2	196	SH2GA5-BSC-2
	41X-Y31A-L	2	196	SH2GA5-BSC-2
	41X-Y31L	2	412	SH2GA5-BSC-2
	41X-Y31R	2	412	SH2GA5-BSC-2
	51X-Y31A-R	2	846	SH2GA5-BSC-2
	51X-Y31A-L	2	846	SH2GA5-BSC-2
	M8-20	24	PCS	SH2GA5-BSC-2
	Si8-16	24	PCS	SH2GA5-BSC-2
	7B33-020	24	PCS	SH2GA5-BSC-2

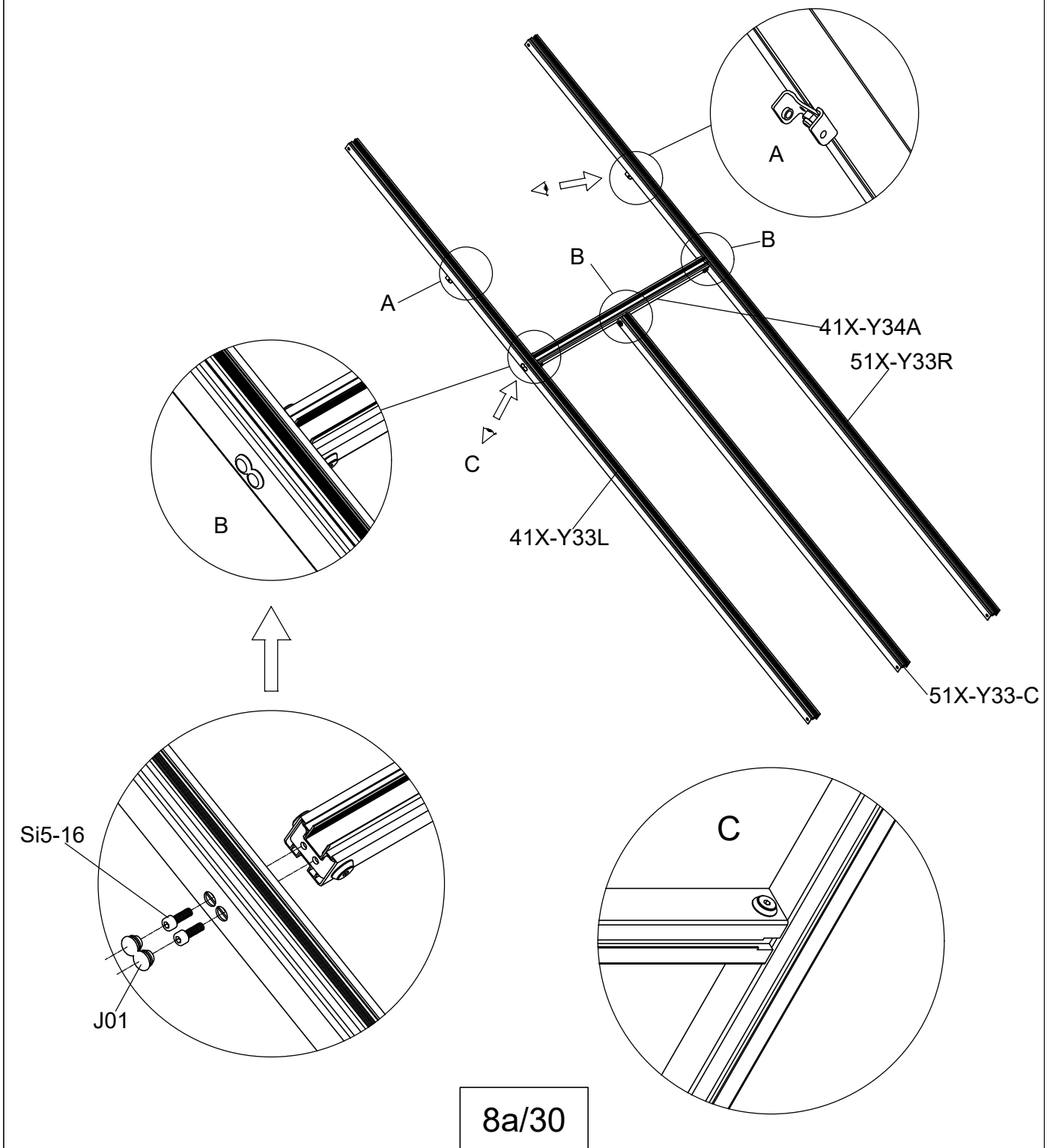

Part	NO.	QTY.			Length(MM)	CTN NO.
		3731	3732	SH2GA5D-2		
	51X-Y33R	2	4	4	2148	
	51X-Y33L	2	4	4	2148	
	41X-Y34A	2	4	4	951	SH2GA5-EXTW-2
	51X-Y33-C	2	4	4	1266	SH2GA5-EXTW-2
	M8-20	8	16	16	PCS	
	M8-20	4	8	8	PCS	SH2GA5-EXTW-2
	7C33-001	8	16	16	PCS	
	7C33-001	4	8	8	PCS	SH2GA5-EXTW-2



Part	NO.	QTY.			Length(MM)	CTN NO.
		3731	3732	3733		
	51X-Y33	2	0	2	2148	
	51X-Y33-B	6	6	8	2148	SH2GA5-EXTN-2

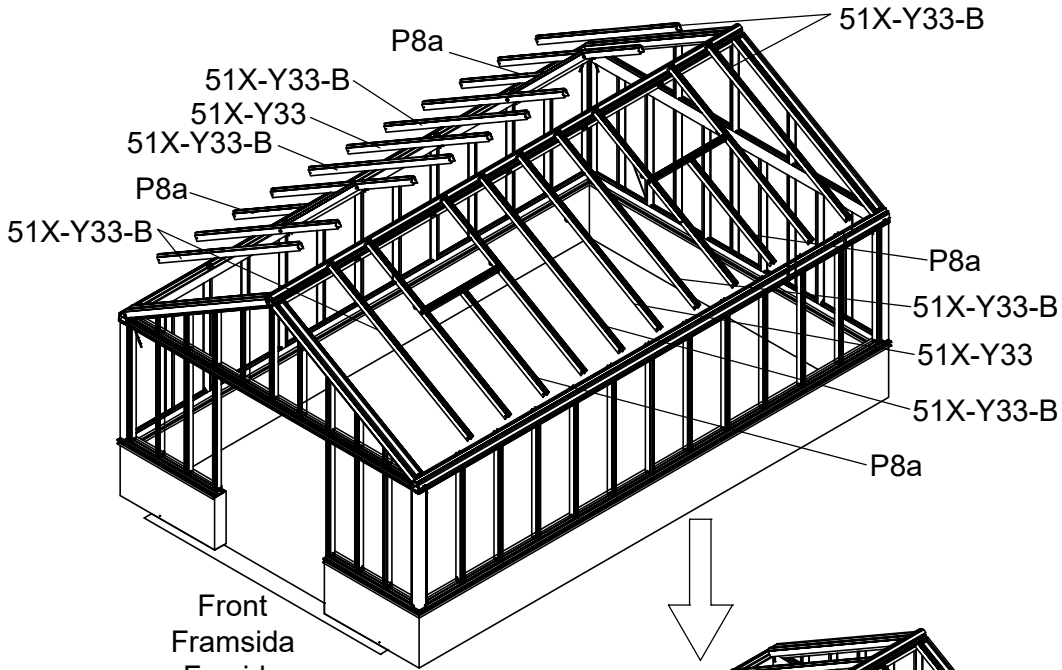

Front
Fransida
Forside
Fransida
Etupuoli

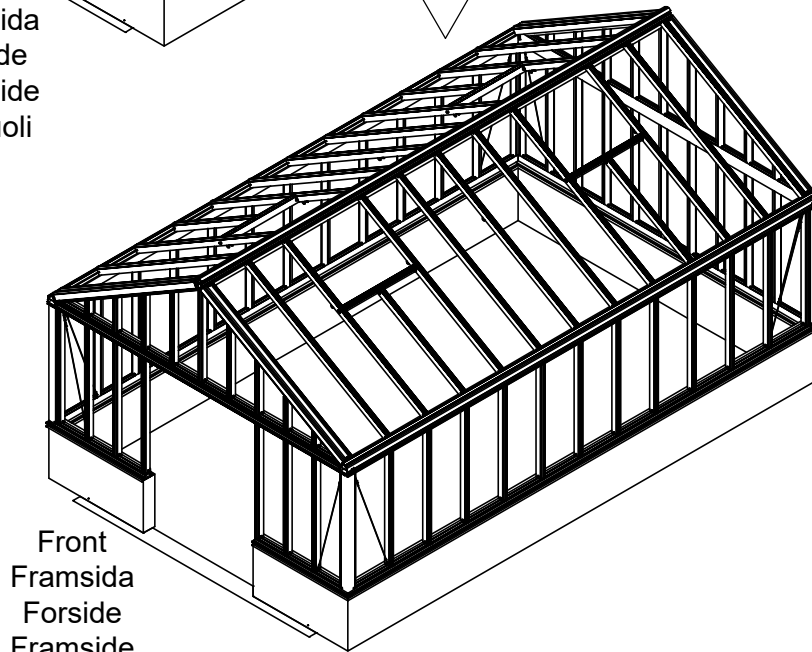

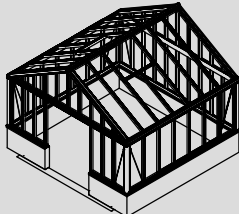
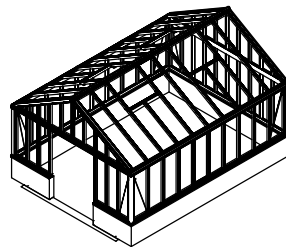
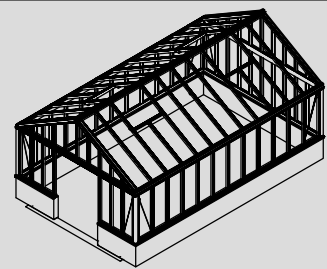

Front
Fransida
Forside
Fransida
Etupuoli

3731	3732	3733
		

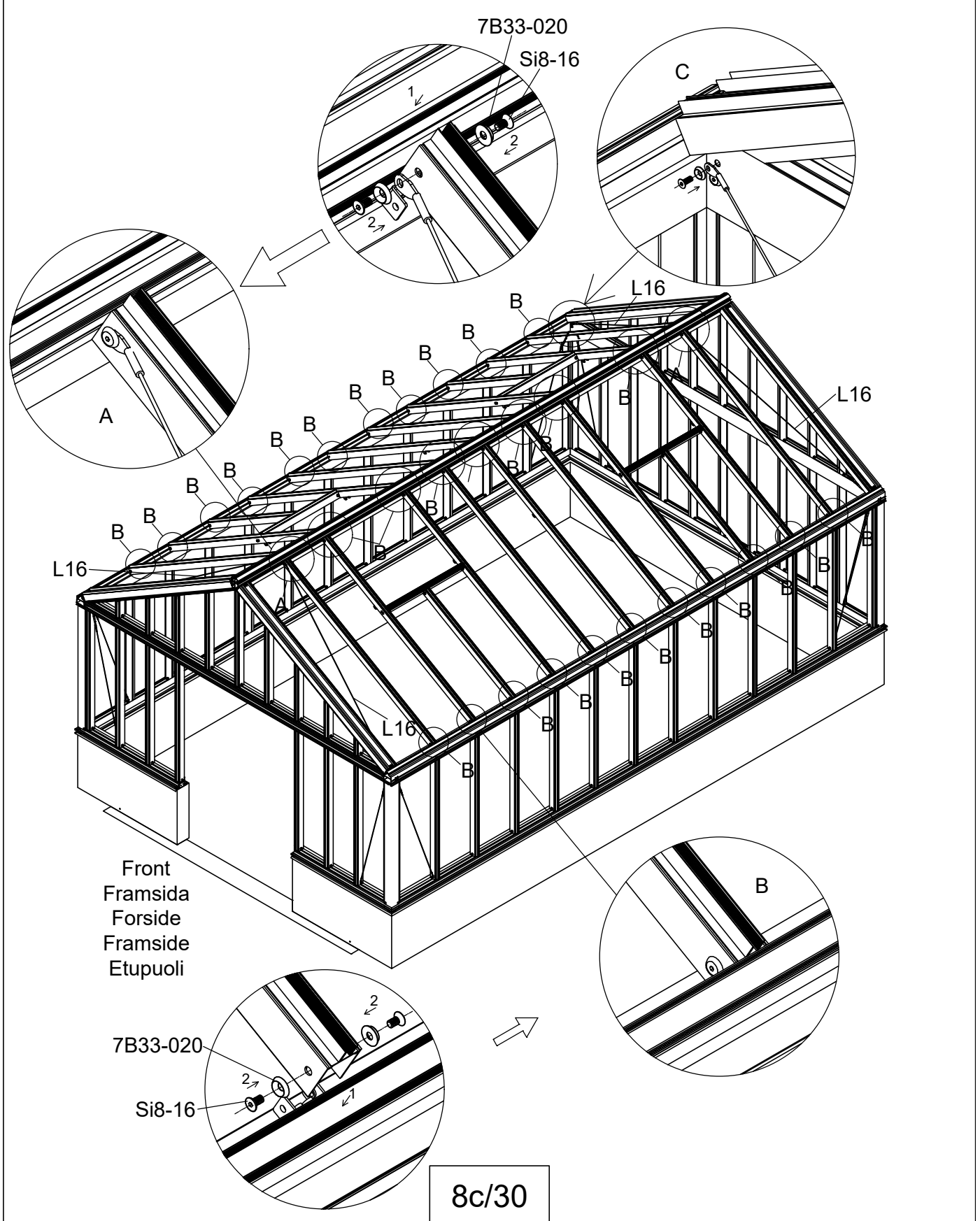

Part	NO.	QTY.									Length (MM)
		3731			3732			3733			
		3731	SH2GA5-EXTN-2	SH2GA5-EXTW-2	3732	SH2GA5-EXTN-2	SH2GA5-EXTW-2	3733	SH2GA5-EXTN-2	SH2GA5-EXTW-2	
	Si8-16	24	24	4	32	24	8	40	32	8	PCS
	7B33-020	24	24	4	32	24	8	40	32	8	PCS
	L16	4									2181

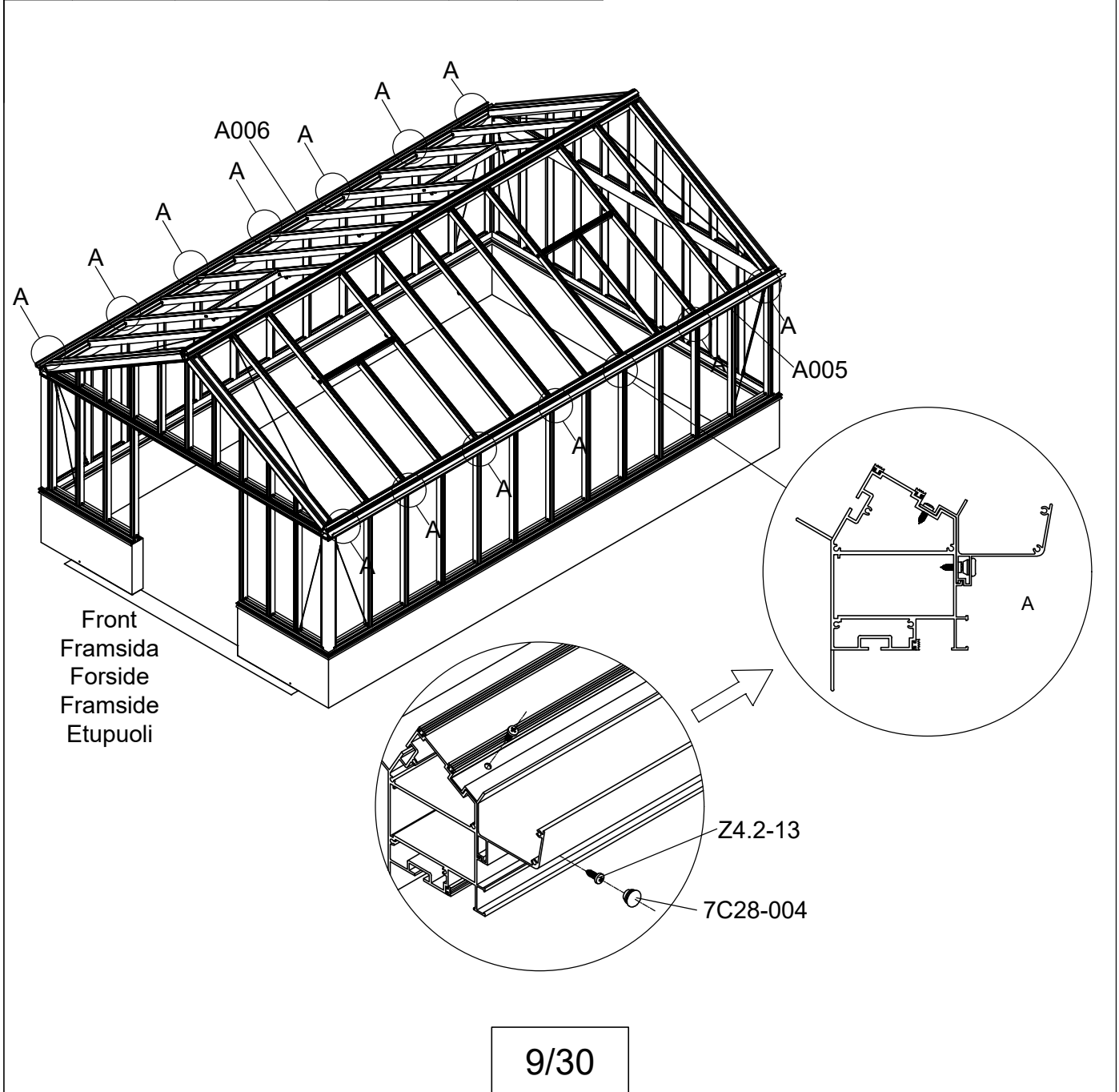

Part	NO.	QTY.			Length(MM)
		3731	3732	3733	
	7C28-004	10	12	14	PCS
	Z4.2-13	20	24	28	PCS

Part	Product	NO.	Length(MM)	QTY.	Code
	3731	41X-Y62-4BR	4228	1	A005
	3732	41X-Y62-5BR	5229		
	3733	41X-Y62-6BR	6230		
	3731	41X-Y62-4BL	4228	1	A006
	3732	41X-Y62-5BL	5229		
	3733	41X-Y62-6BL	6230		



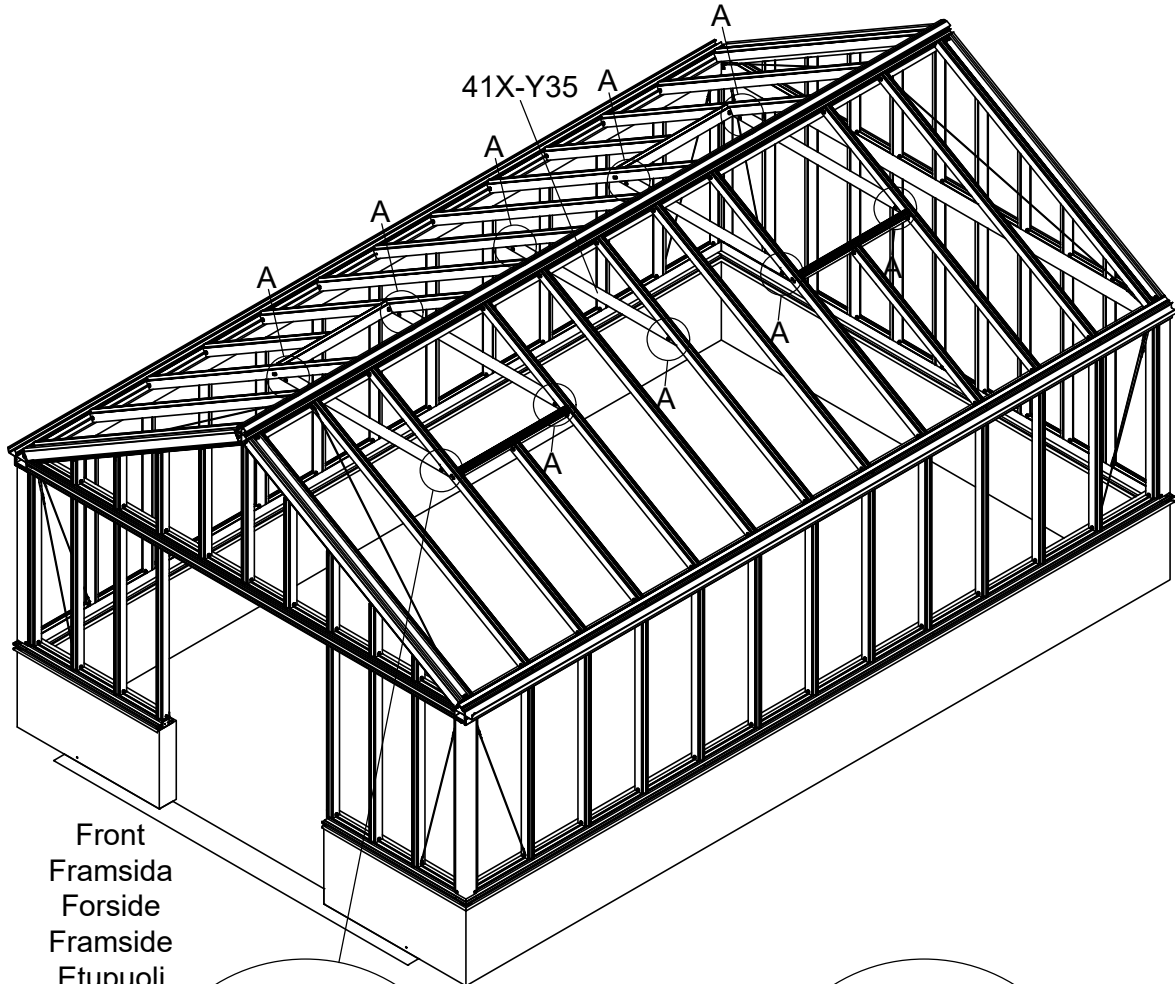

Part	NO.	QTY.			Length(MM)
		3731	3732	3733	
	41X-Y35	3	4	5	1500
	Si8-16	12	16	20	PCS
	7B33-020	12	16	20	PCS

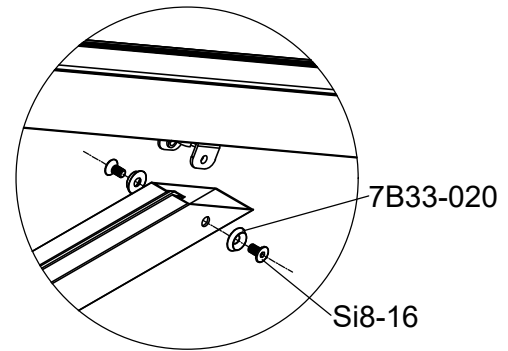
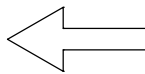
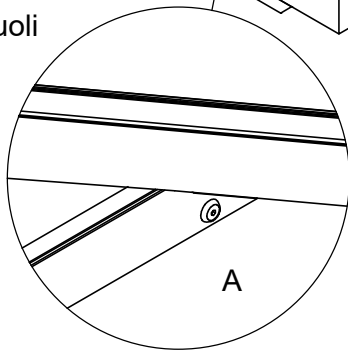

Front
Framsida
Forside
Framsida
Etupuoli

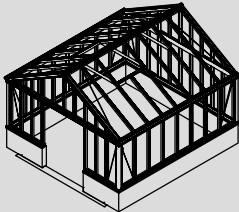
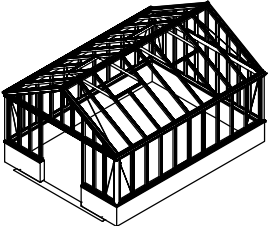
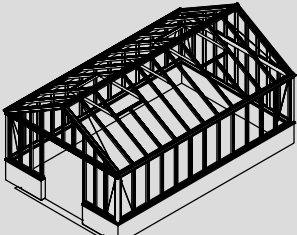

3731	3732	3733
		

Part	NO.	QTY.												Length (MM)
		3731				3732				3733				
		3731	SH2GA5-BSC-2	SH2GA5-EXTN-2	SH2GA5-EXTW-2	3732	SH2GA5-BSC-2	SH2GA5-EXTN-2	SH2GA5-EXTW-2	3733	SH2GA5-BSC-2	SH2GA5-EXTN-2	SH2GA5-EXTW-2	
	J12	51	21	18	6	57	21	18	12	63	21	24	12	PCS

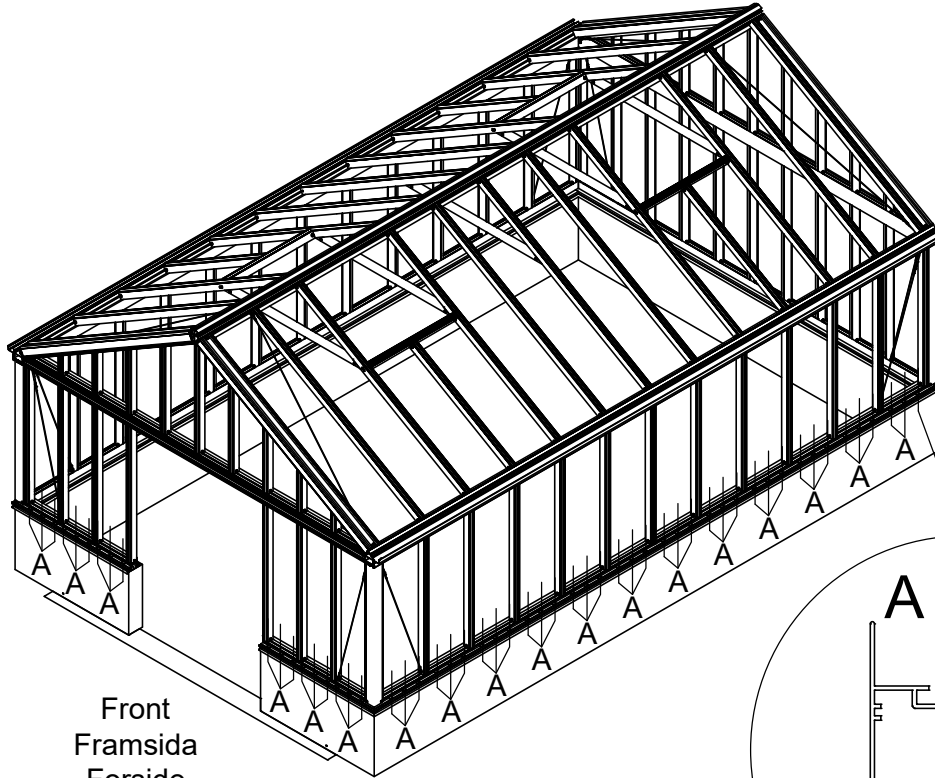

Front
 Framsida
 Forside
 Framside
 Etupuoli

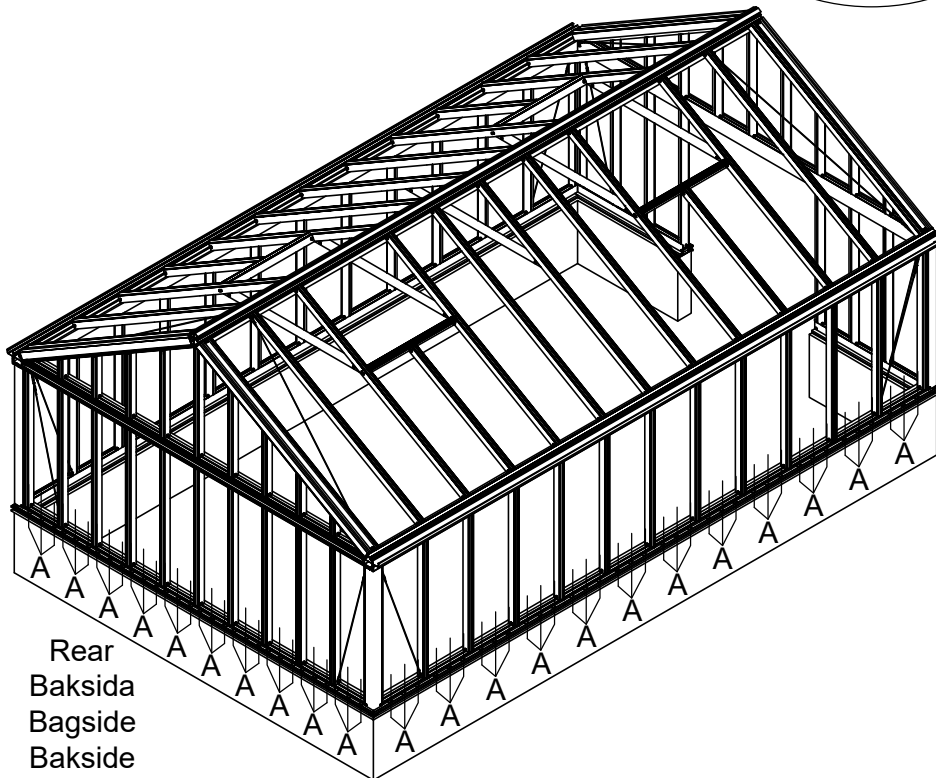
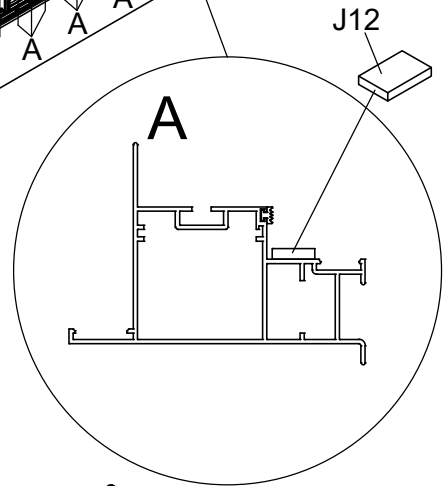

Rear
 Baksida
 Bagside
 Baksida
 Takapuoli

Part	NO.	QTY.			Length(MM)
		3731	3732	3733	
<input type="checkbox"/>	354×1369	6	6	6	1369
<input type="checkbox"/>	479×1369	8	10	12	1369

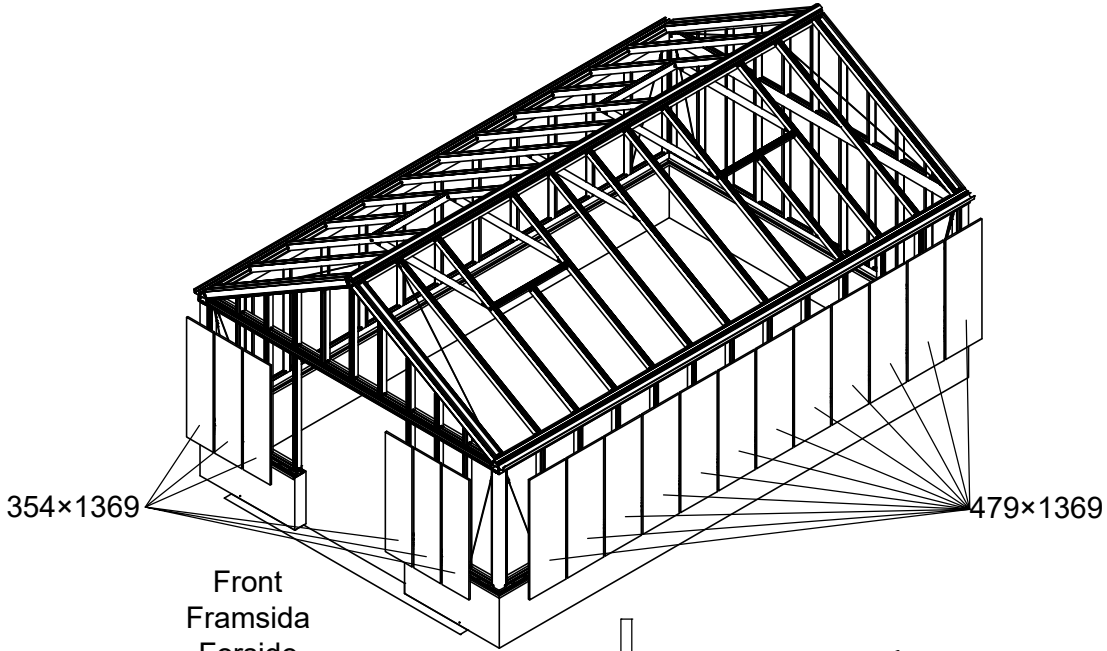

Front
 Framsida
 Forside
 Framside
 Etupuoli

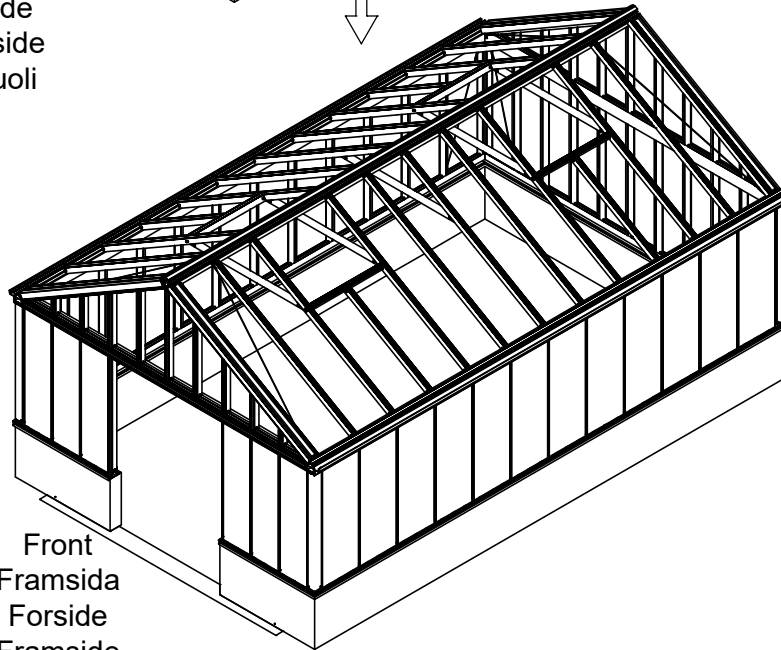

Front
 Framsida
 Forside
 Framside
 Etupuoli

3731

3732

3733

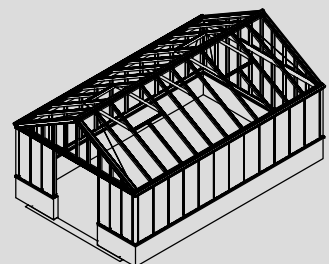
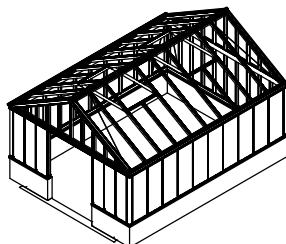
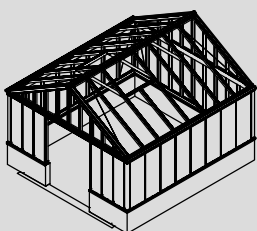

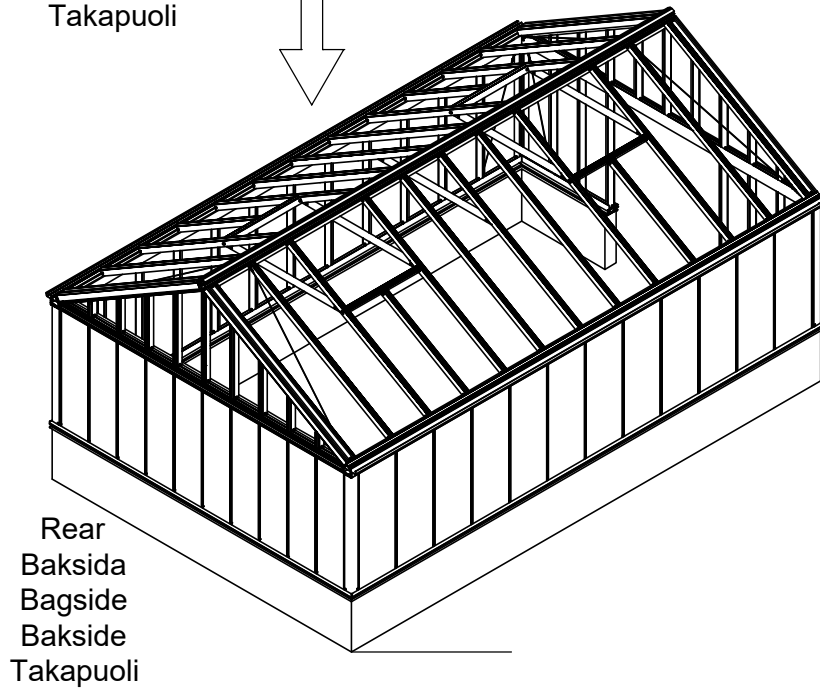
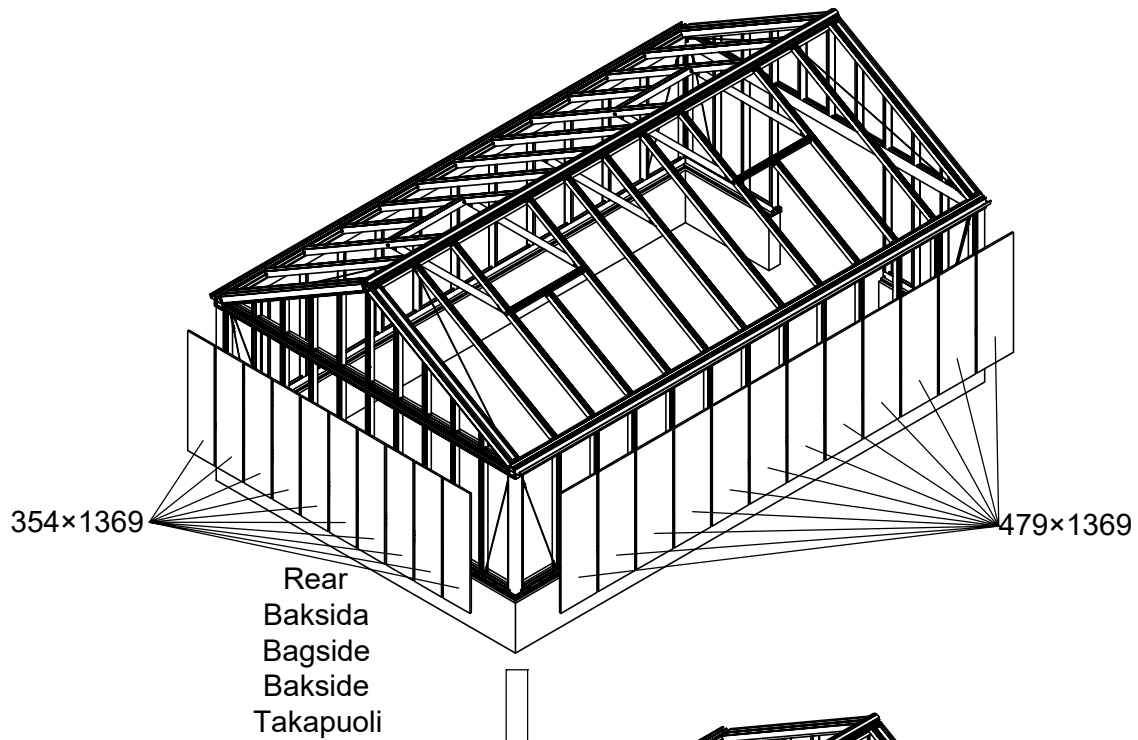

11b/30

Part	NO.	QTY.			Length(MM)
		3731	3732	3733	
<input type="checkbox"/>	354×1369	10	10	10	1369
<input type="checkbox"/>	479×1369	8	10	12	1369



3731	3732	3733

11c/30

Part	NO.	QTY.	Length(MM)
	51A-Y14L	1	1270
	51A-Y14R	1	1270
	51X-Y14	1	3990

Part	Product	NO.	Length(MM)	QTY.	Code
	3731	41X-Y15-4	4239	2	A007
	3732	41X-Y15-5	5240		
	3733	41X-Y15-6	6241		

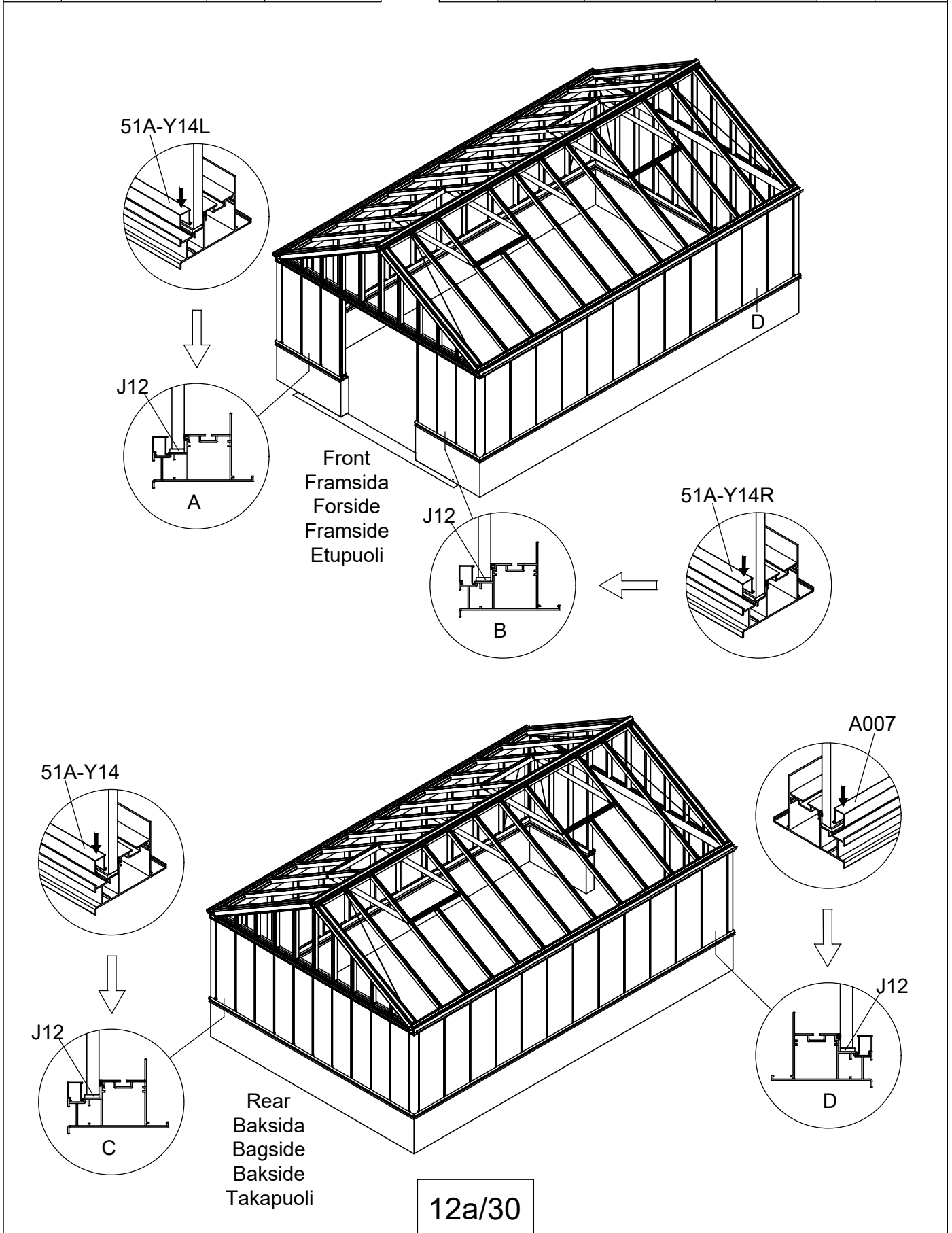

Part	NO.	3731			3732			3733			Length (MM)			
		3731	SH2GA5-BSC-2	SH2GA5-EXTN-2	SH2GA5-EXTW-2	3732	SH2GA5-BSC-2	SH2GA5-EXTN-2	SH2GA5-EXTW-2	3733		SH2GA5-BSC-2	SH2GA5-EXTN-2	SH2GA5-EXTW-2
			41X-Y01	7	2	3	1	8	2	3		2	9	2
	41X-Y02	4											1335	

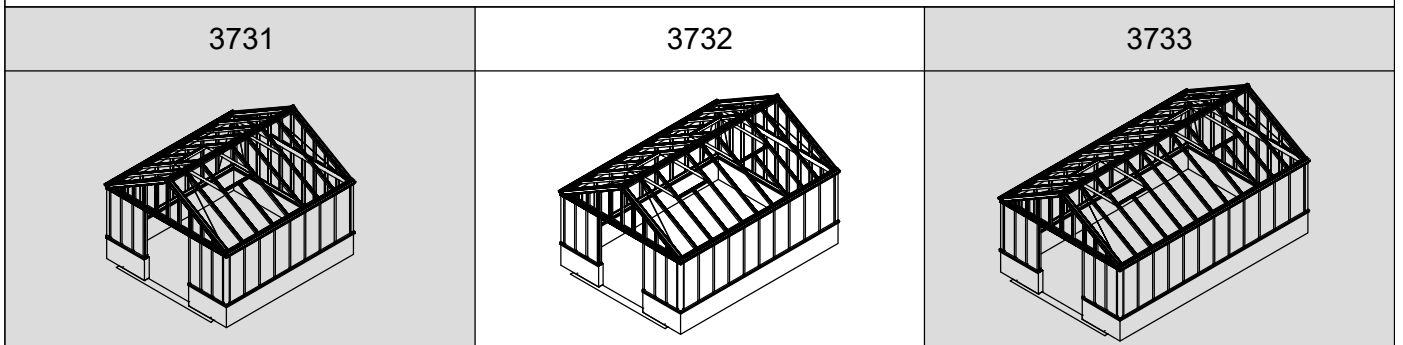
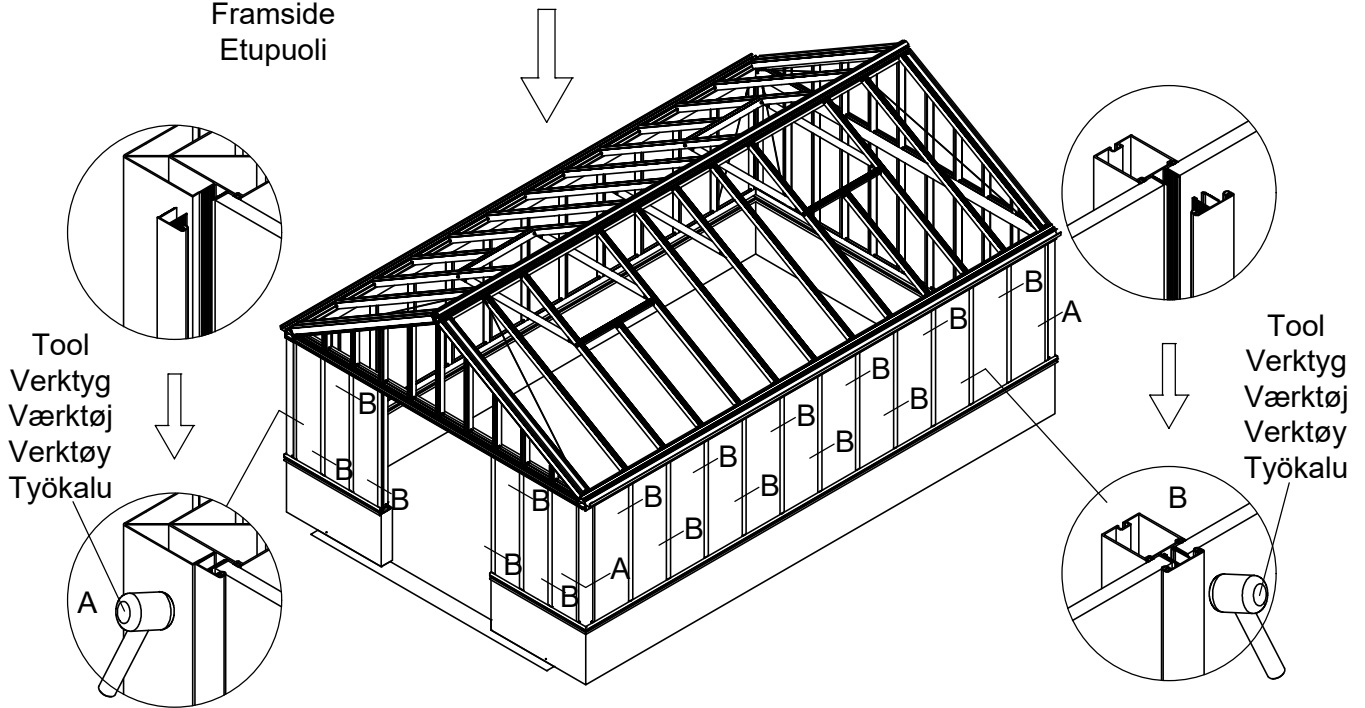
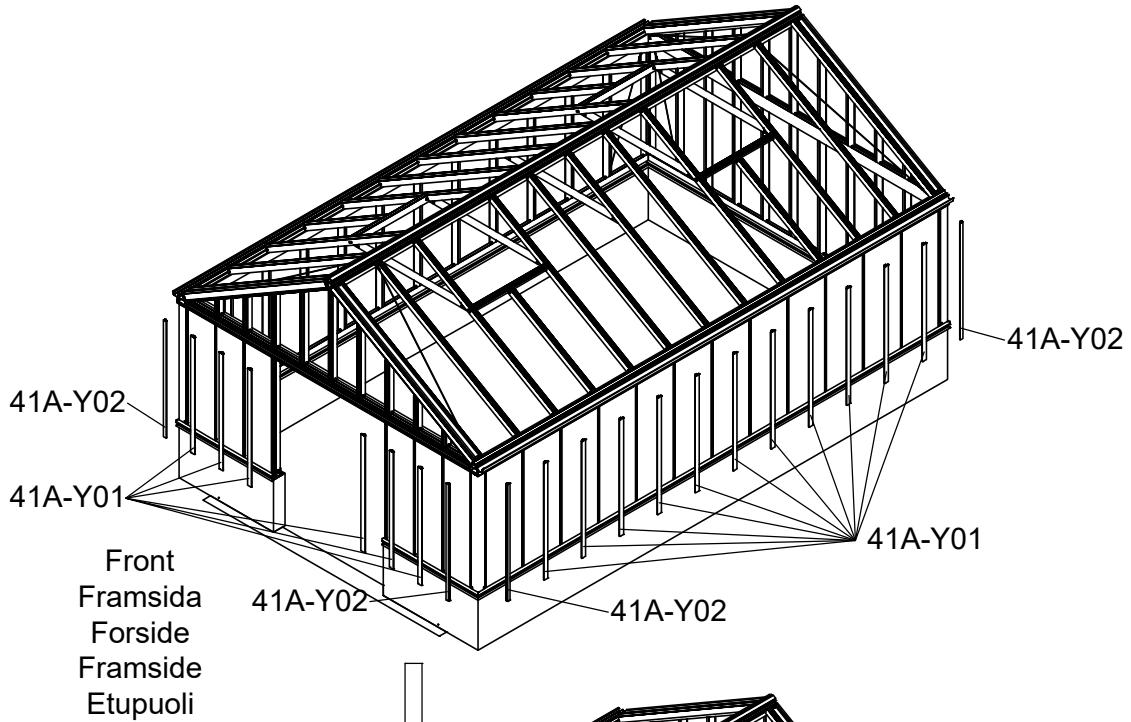

Part	NO.	QTY.												Length (MM)
		3731				3732				3733				
		3731	SH2GA5-BSC-2	SH2GA5-EXTN-2	SH2GA5-EXTW-2	3732	SH2GA5-BSC-2	SH2GA5-EXTN-2	SH2GA5-EXTW-2	3733	SH2GA5-BSC-2	SH2GA5-EXTN-2	SH2GA5-EXTW-2	
	41X-Y01	7	5	3	1	8	5	3	2	9	5	4	2	1335
	41X-Y02	4												1335

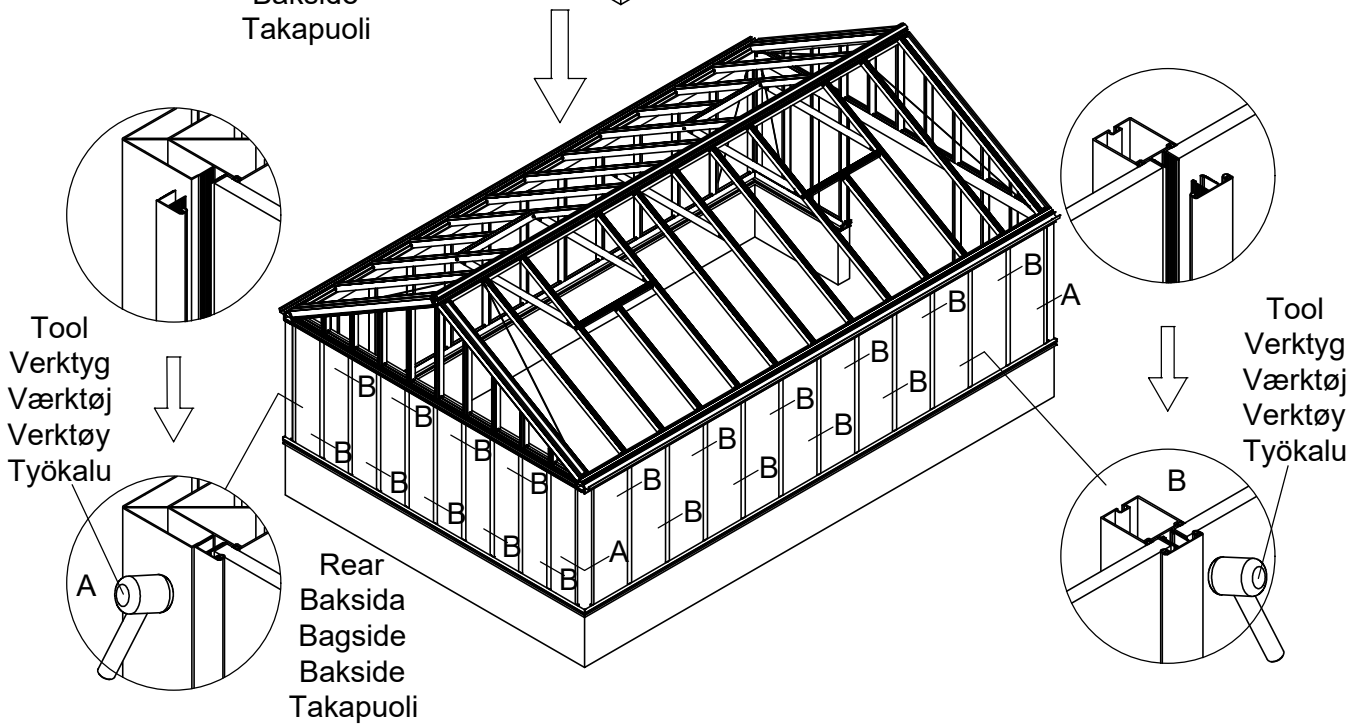
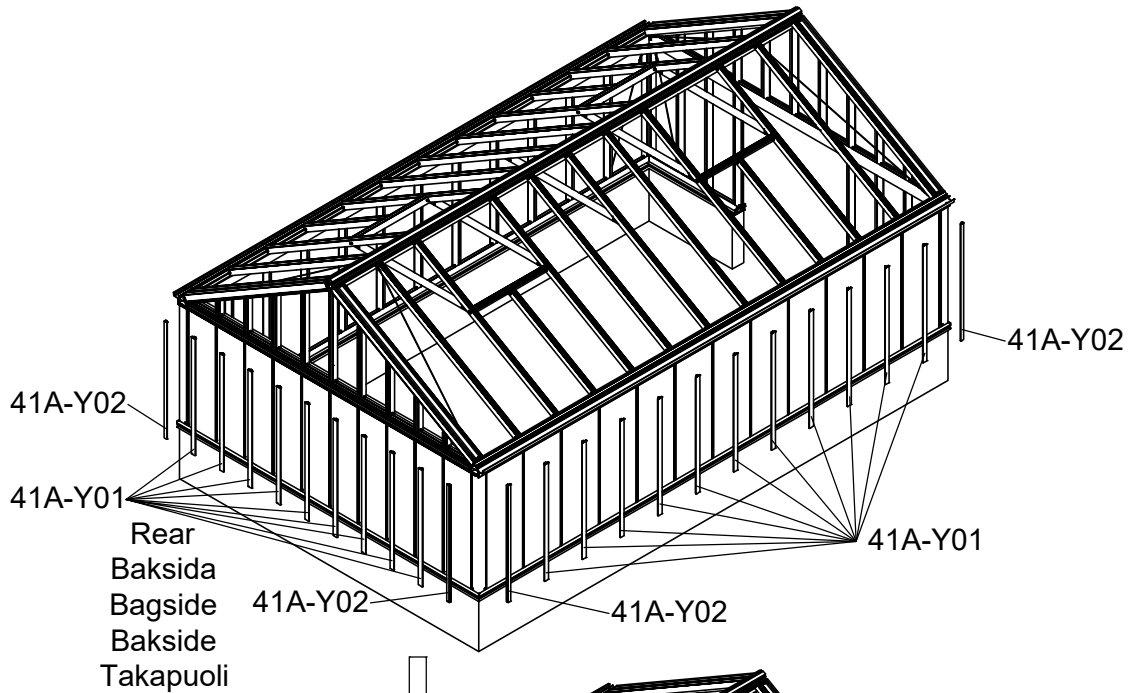

3731

3732

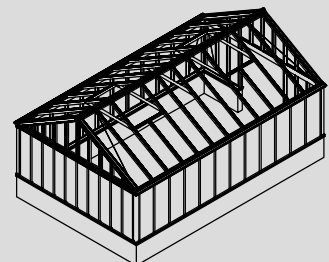
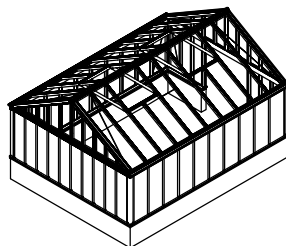
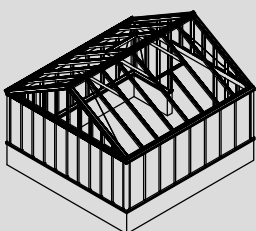

3733

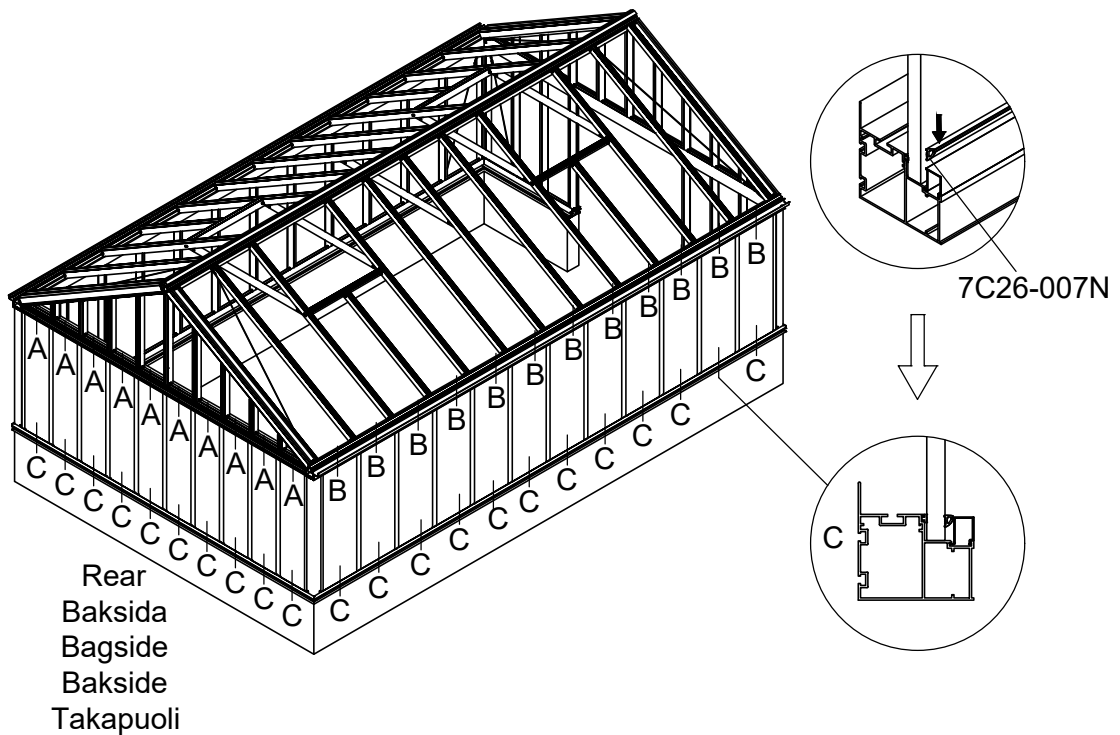
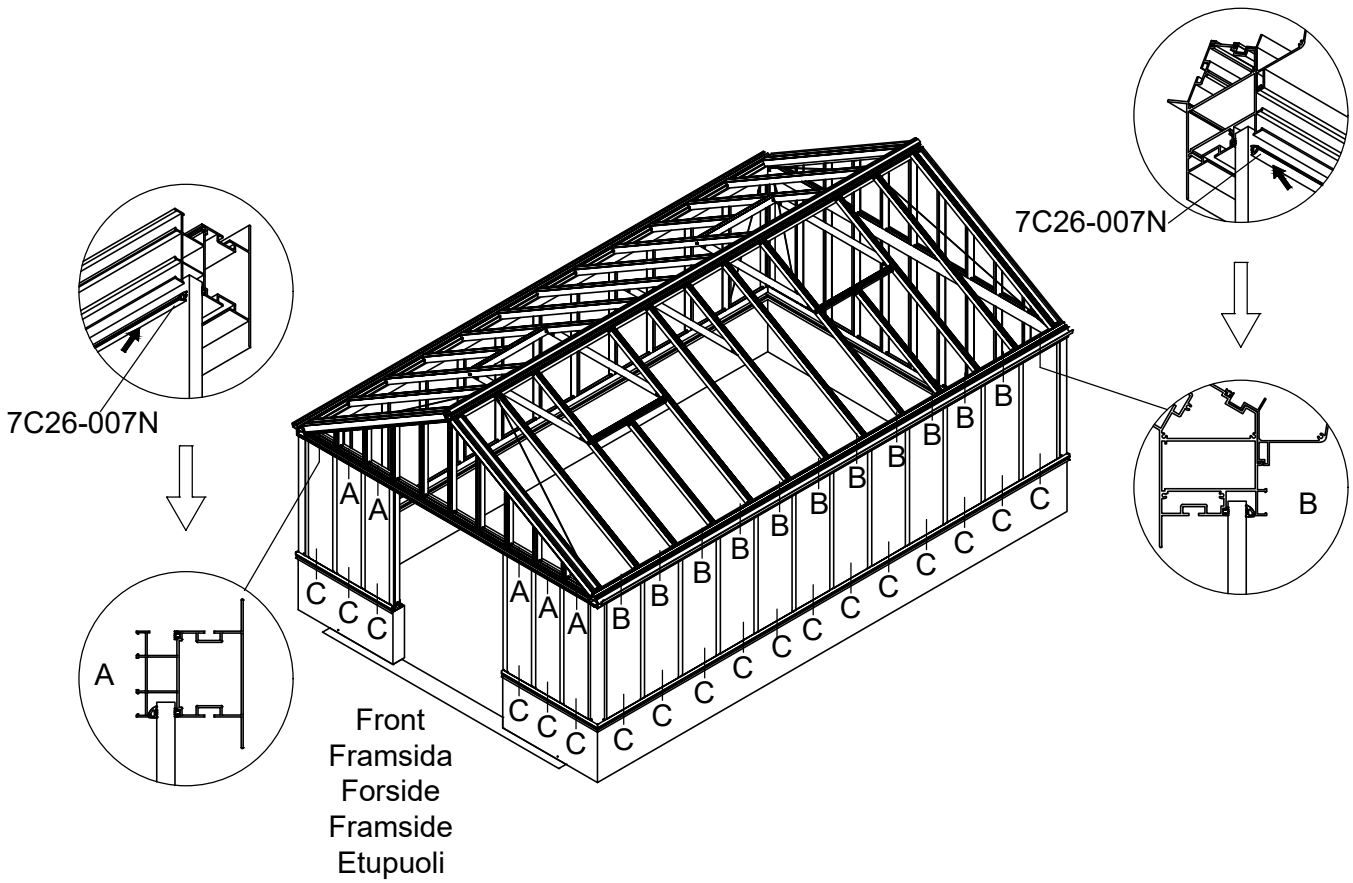

12c/30

Part	NO.	QTY.			Length(MM)
		3731	3732	3733	
	7C26-007N	28	32	36	PCS





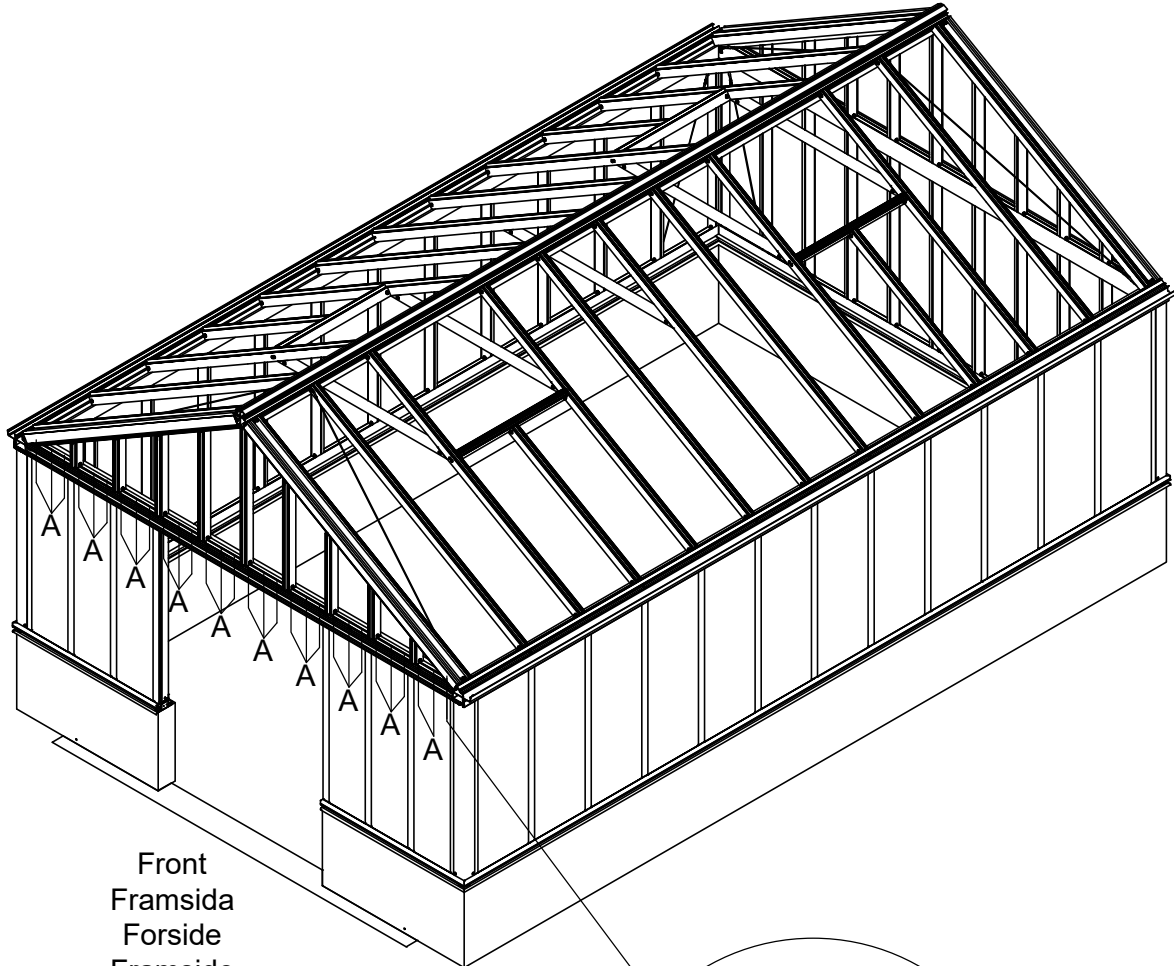

Part	NO.	QTY.	Length(MM)	
	J12	12	PCS	
	J12	18	PCS	SH2GA5-BSC-2

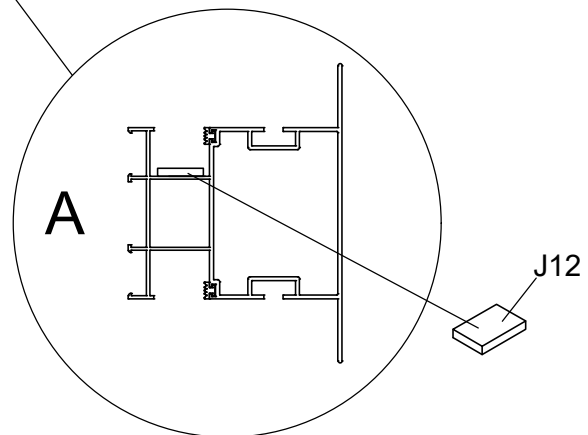





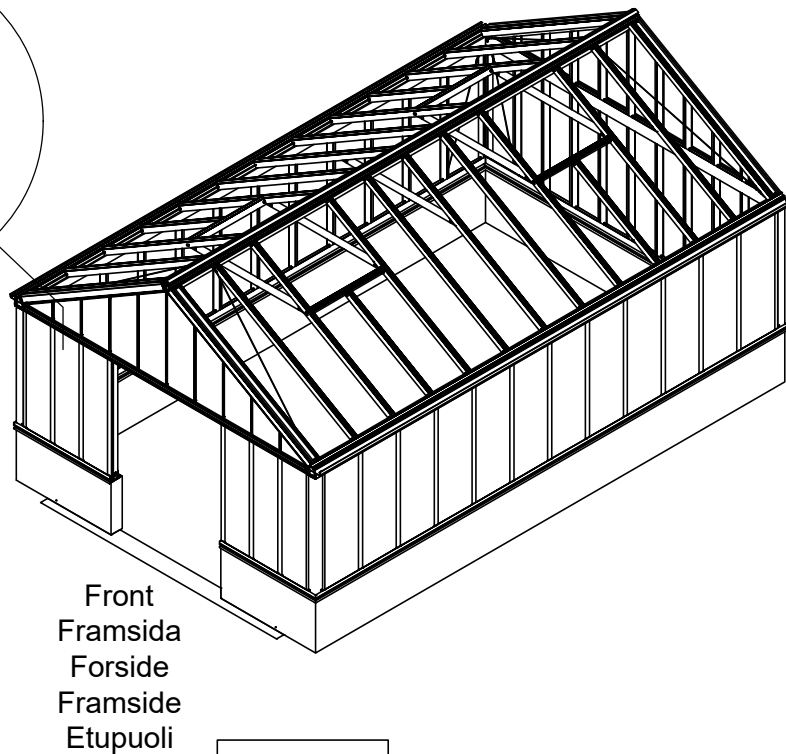
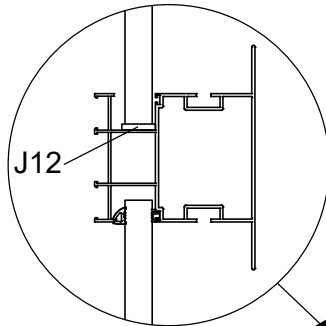
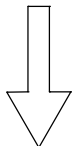
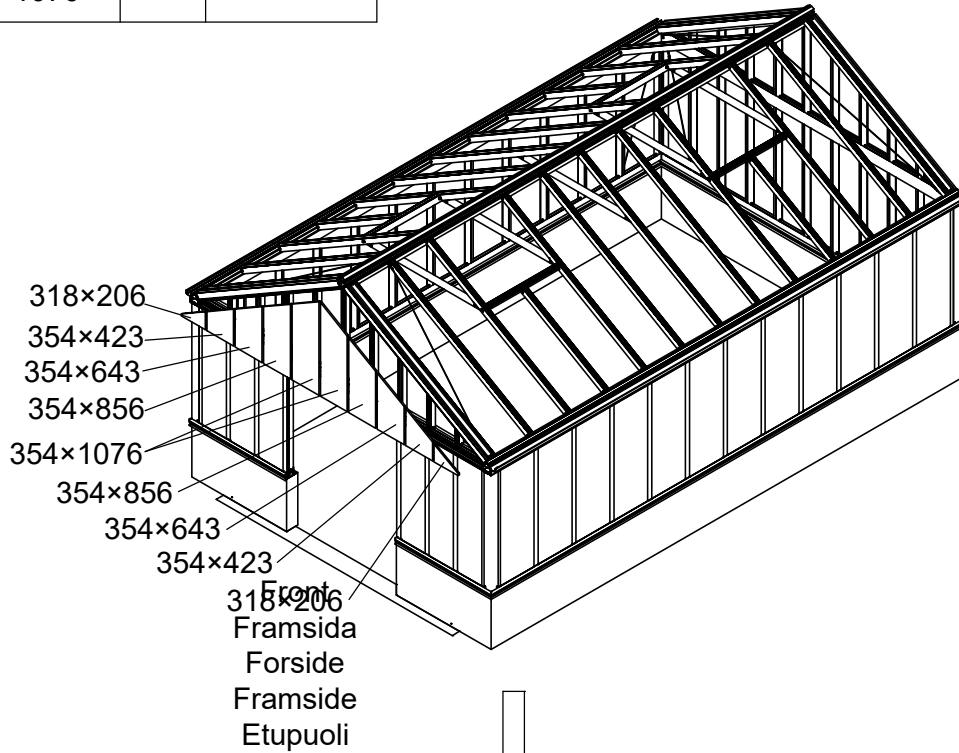

Front
 Framsida
 Forside
 Framside
 Etupuoli



Part	NO.	QTY.	Length(MM)
	318×206	2	318
	354×423	2	423
	354×643	2	643
	354×856	2	856
	354×1076	2	1076



Part	NO.	QTY.	Length(MM)
	51X-Y03	1	1074
	51X-Y04R	1	629
	51X-Y04L	1	629
	51X-Y05R	1	2147
	51X-Y05L	1	2147

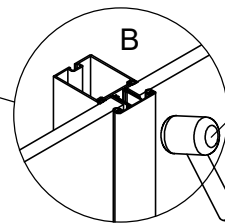
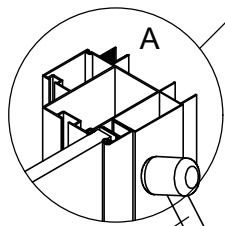
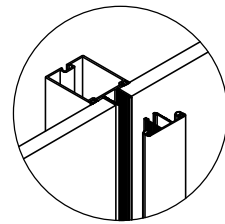
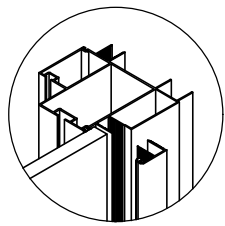
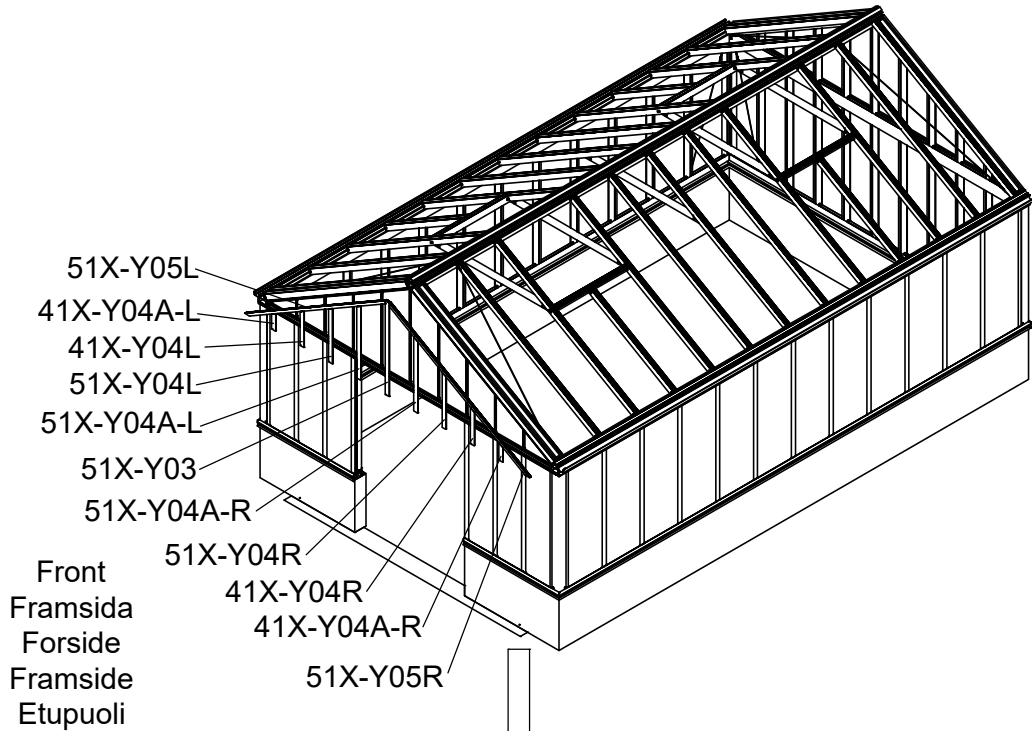

Part	NO.	QTY.	Length(MM)	CTN NO.
	41X-Y04A-R	1	196	SH2GA5-BSC-2
	41X-Y04A-L	1	196	SH2GA5-BSC-2
	41X-Y04R	1	412	SH2GA5-BSC-2
	41X-Y04L	1	412	SH2GA5-BSC-2
	51X-Y04A-R	1	846	SH2GA5-BSC-2
	51X-Y04A-L	1	846	SH2GA5-BSC-2



Tool
Verktøj
Værktøj
Verktøy
Työkälu

Front
Framsida
Forside
Framside
Etupuoli



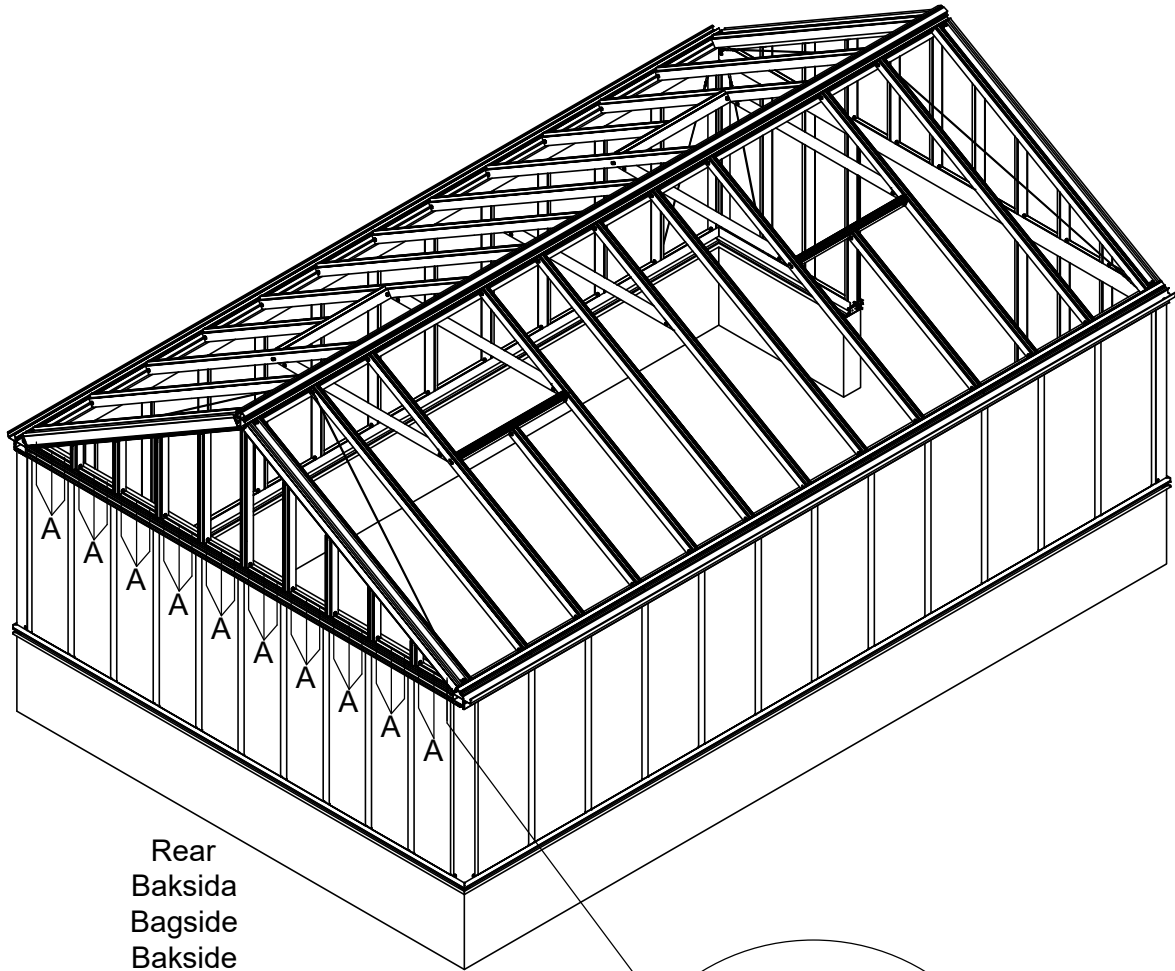

Tool
Verktøj
Værktøj
Verktøy
Työkälu

Part	NO.	QTY.	Length(MM)	
	J12	12	PCS	
	J12	18	PCS	SH2GA5-BSC-2

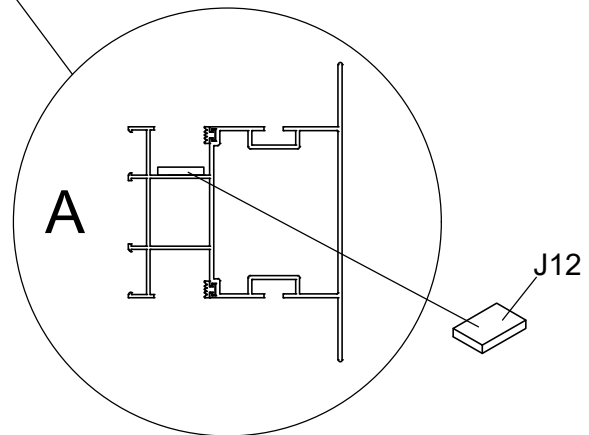

Rear
Baksida
Bagside
Baksida
Takapuoli



Part	NO.	QTY.	Length(MM)
	318×206	2	318
	354×423	2	423
	354×643	2	643
	354×856	2	856
	354×1076	2	1076

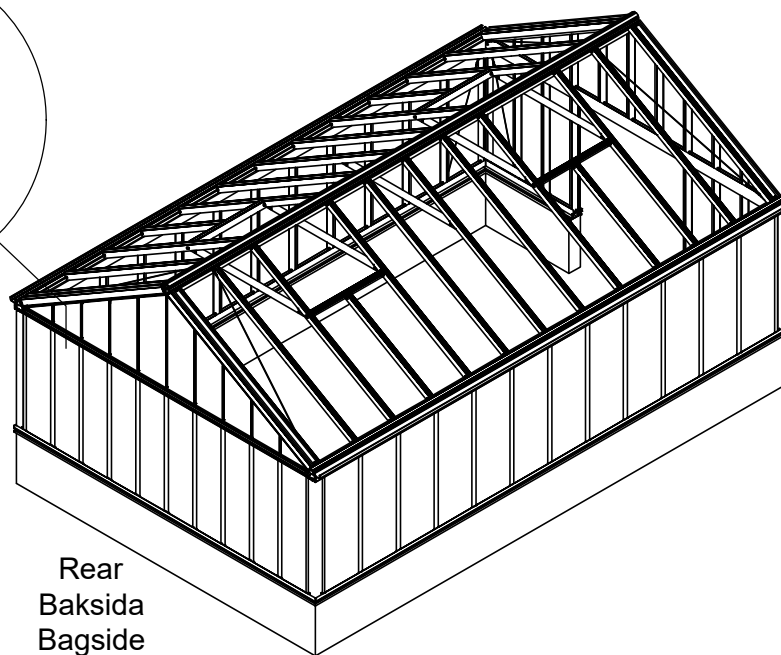
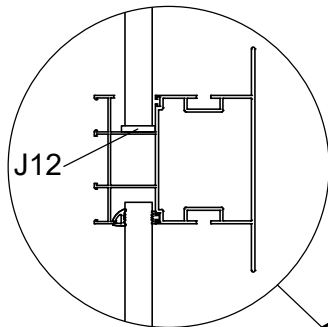
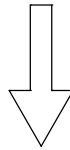
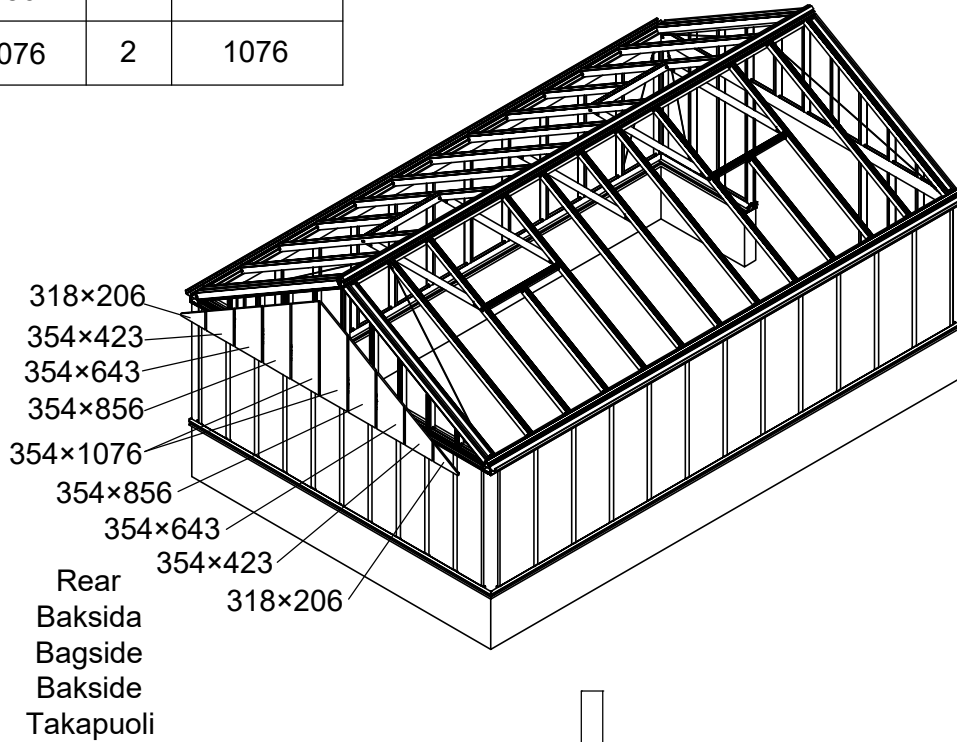

15b/30

Part	NO.	QTY.	Length(MM)
	51X-Y03	1	1074
	51X-Y04R	1	629
	51X-Y04L	1	629
	51X-Y05R	1	2147
	51X-Y05L	1	2147

Part	NO.	QTY.	Length(MM)	CTN NO.
	41X-Y04A-R	1	196	SH2GA5-BSC-2
	41X-Y04A-L	1	196	SH2GA5-BSC-2
	41X-Y04R	1	412	SH2GA5-BSC-2
	41X-Y04L	1	412	SH2GA5-BSC-2
	51X-Y04A-R	1	846	SH2GA5-BSC-2
	51X-Y04A-L	1	846	SH2GA5-BSC-2

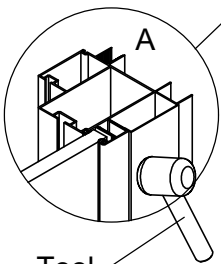
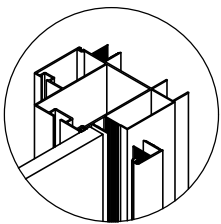
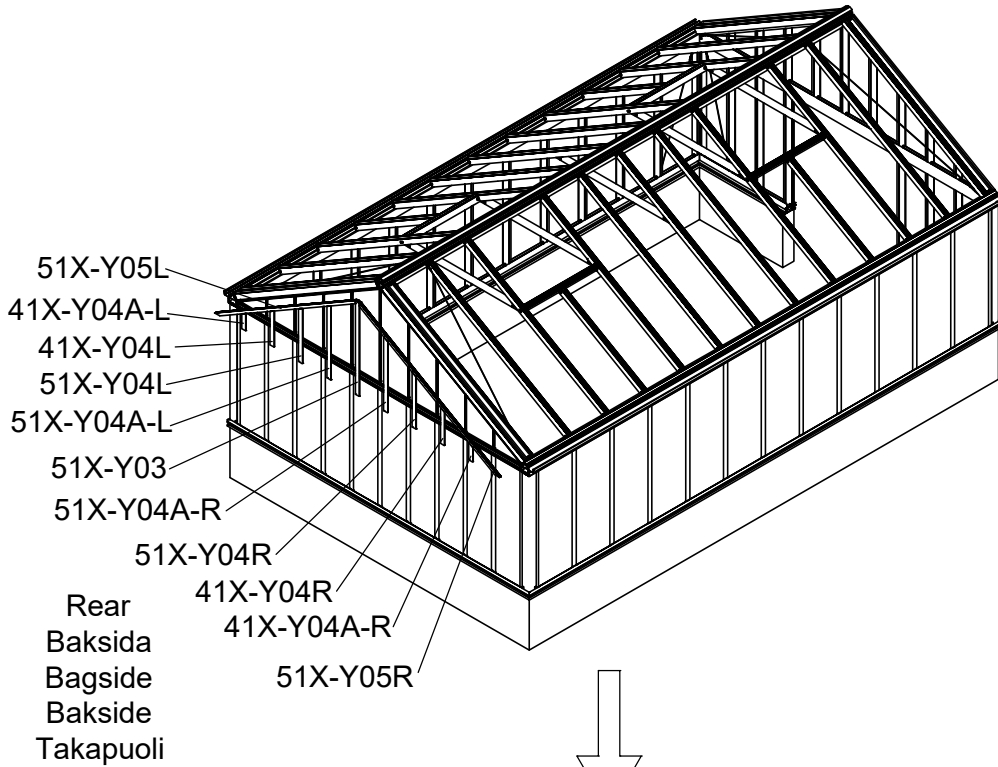

Tool
Verktøj
Værktøj
Verktøy
Työkälu

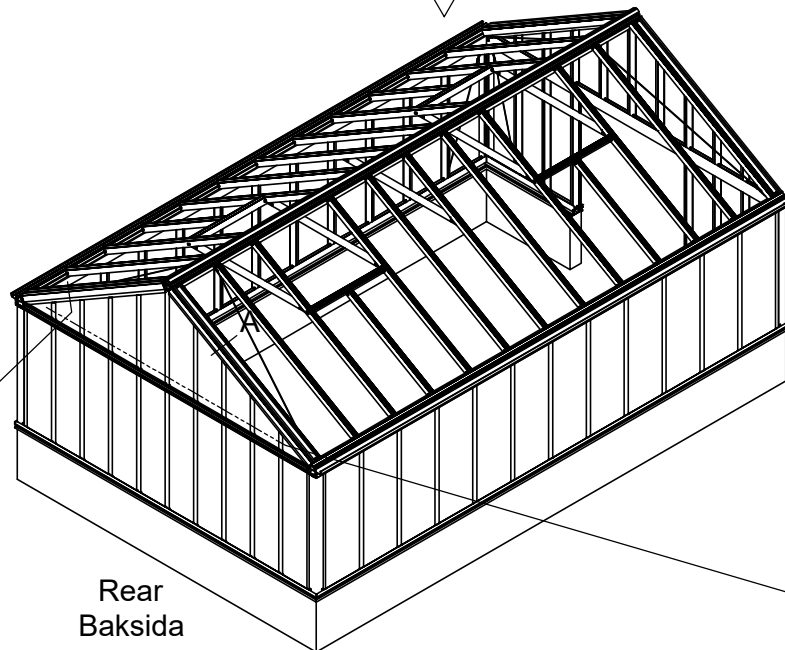

Rear
Baksida
Bagside
Baksida
Takapuoli

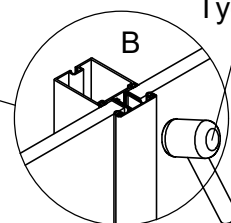
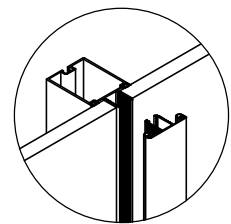

Tool
Verktøj
Værktøj
Verktøy
Työkälu

15c/30

Part	NO.	QTY.	Length(MM)
	7C26-007N	7.5M	

7C26-007N

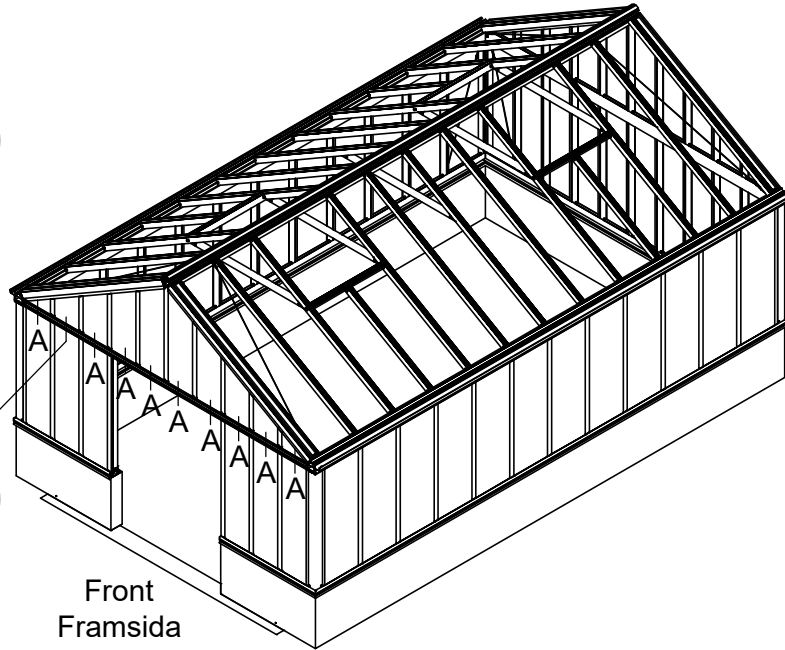
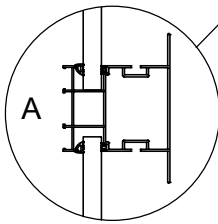
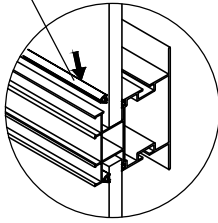

Front
Framsida
Forside
Framsida
Etupuoli

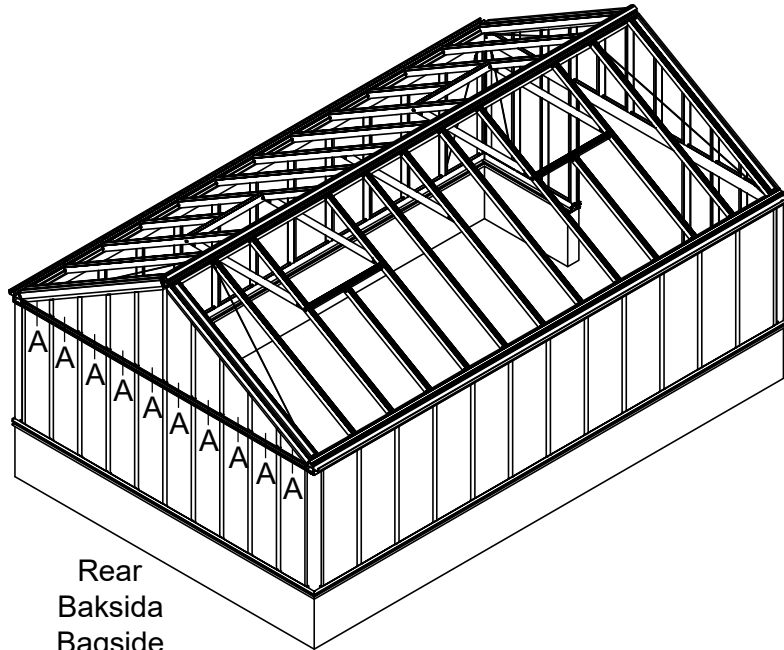

Rear
Baksida
Bagside
Baksida
Takapuoli

Part	NO.	QTY.									Length (MM)
		3731			3732			3733			
		3721	SH2GA5-EXTN-2	SH2GA5-EXTW-2	3732	SH2GA5-EXTN-2	SH2GA5-EXTW-2	3733	SH2GA1-EXTN-2	SH2GA1-EXTW-2	
	J12	24	18	6	30	18	12	36	24	12	PCS

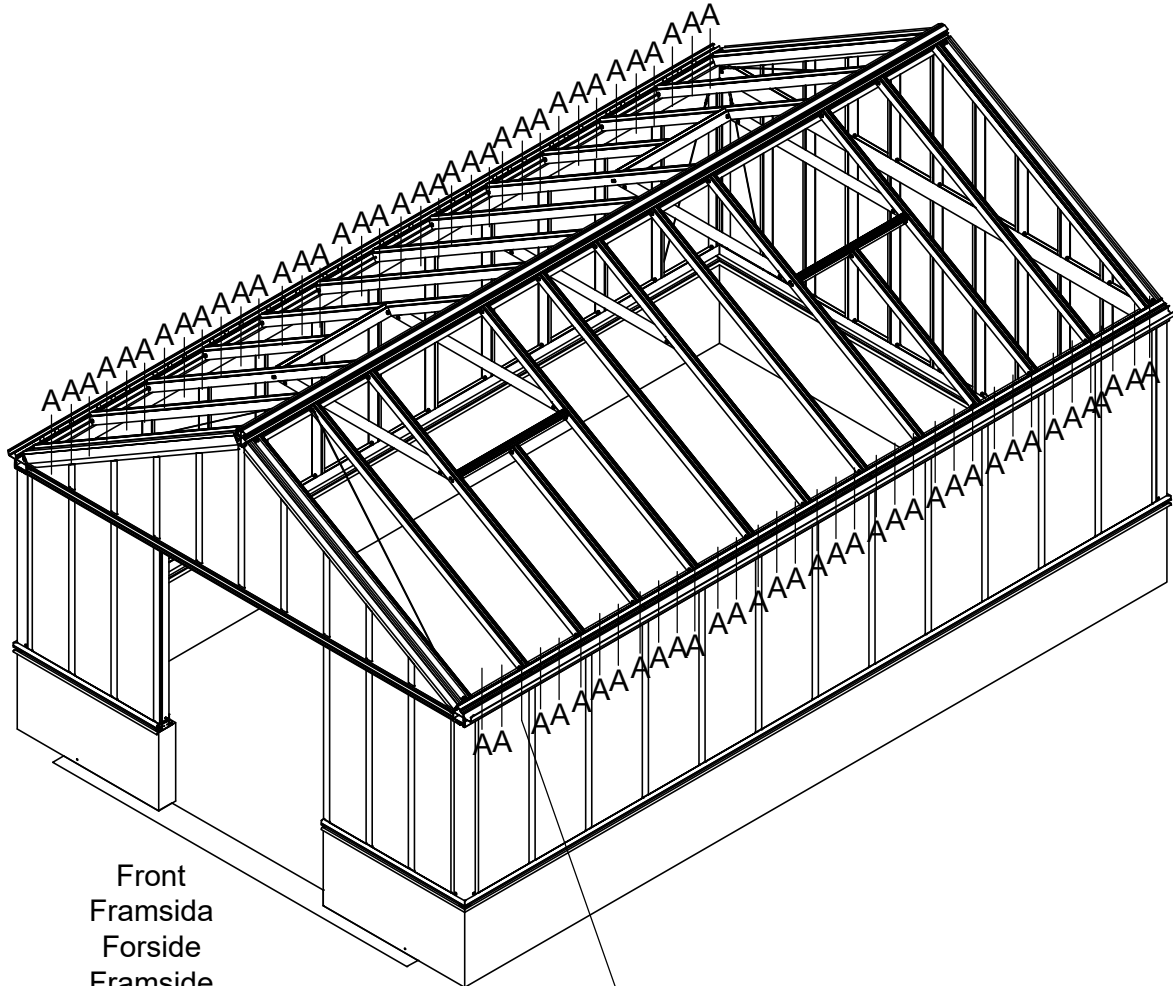

Front
Framsida
Forside
Framsida
Etupuoli

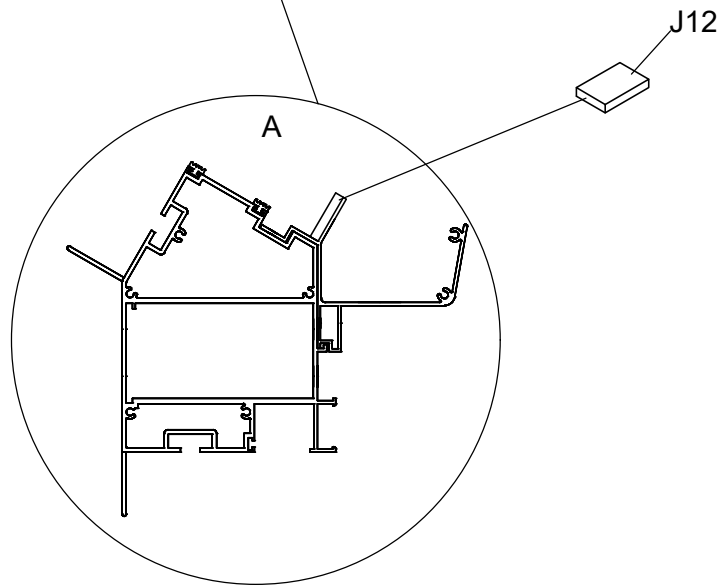

Part	NO.	QTY.			Length(MM)
		3731	3732	3733	
	479x2234	12	12	16	2234
	479x1343	4	8	8	1343

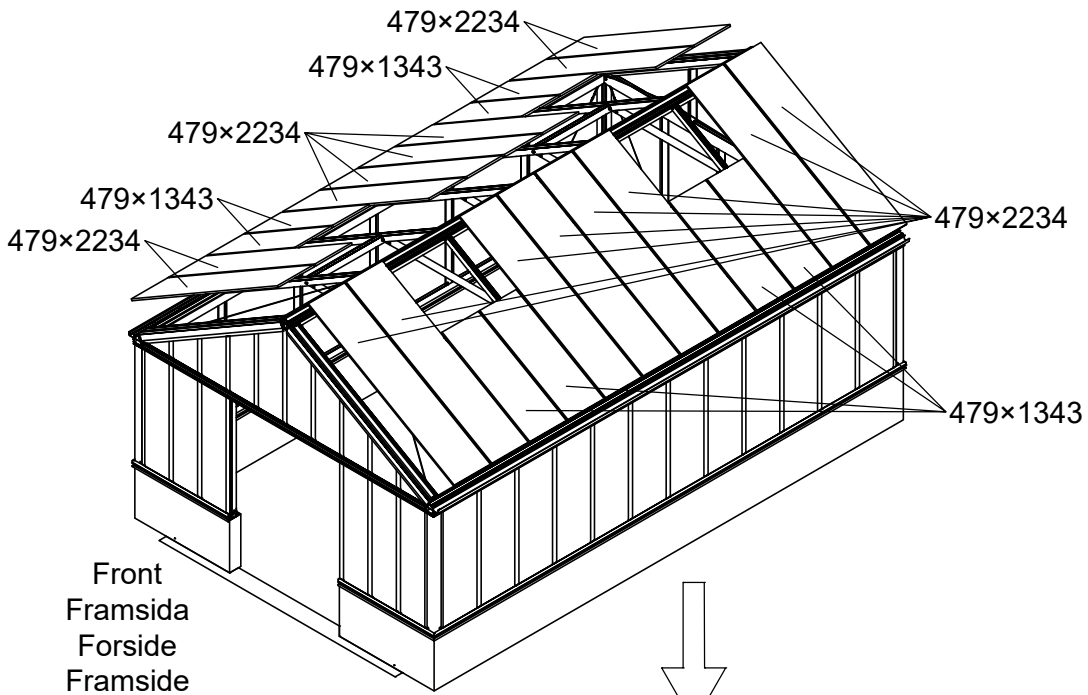

Front
Framsida
Forside
Framsida
Etupuoli

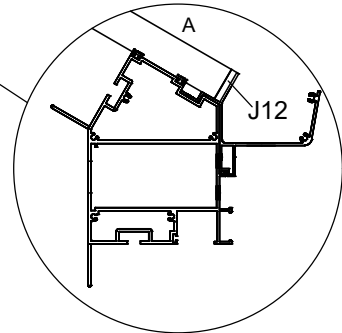
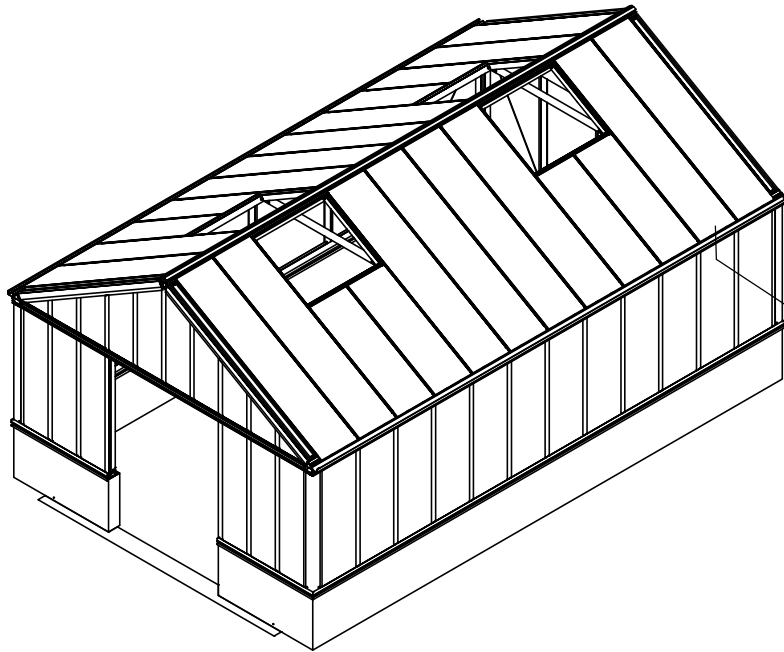





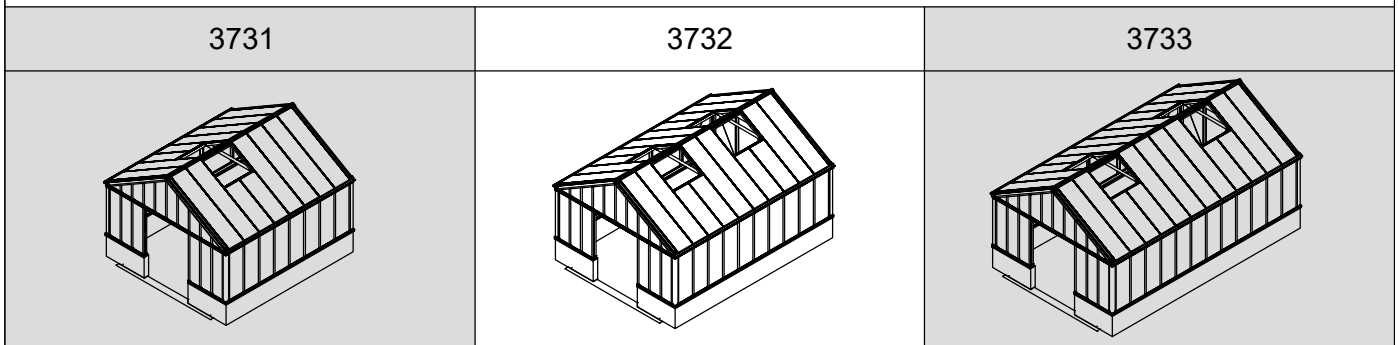
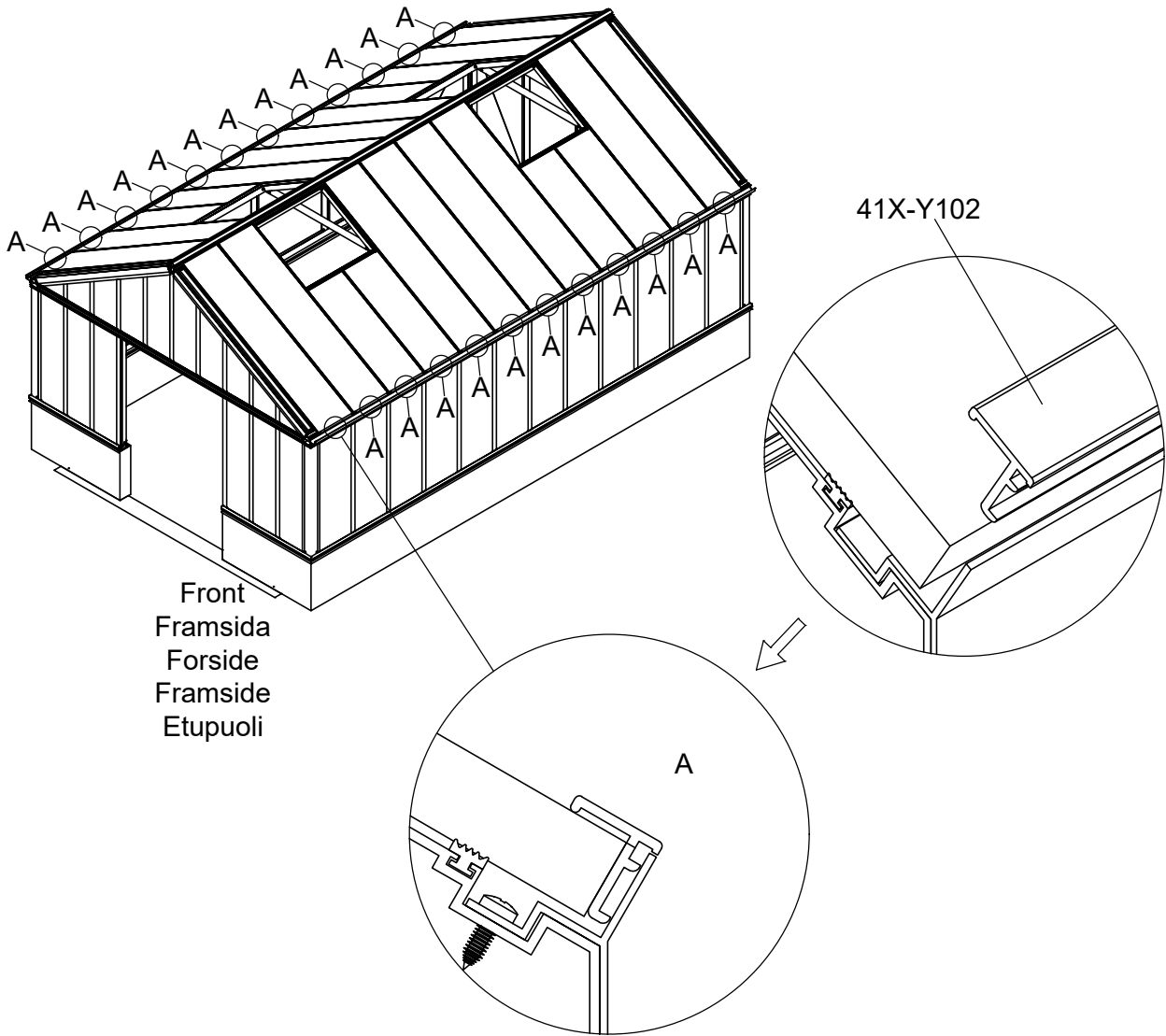

3731	3732	3733

17b/30

Part	NO.	QTY.						Length (MM)
		3731		3732		3733		
		SH2GA5- EXTN-2	SH2GA5- EXTW-2	SH2GA5- EXTN-2	SH2GA5- EXTW-2	SH2GA5- EXTN-2	SH2GA5- EXTW-2	
	41X-Y102	12	4	12	8	16	8	480



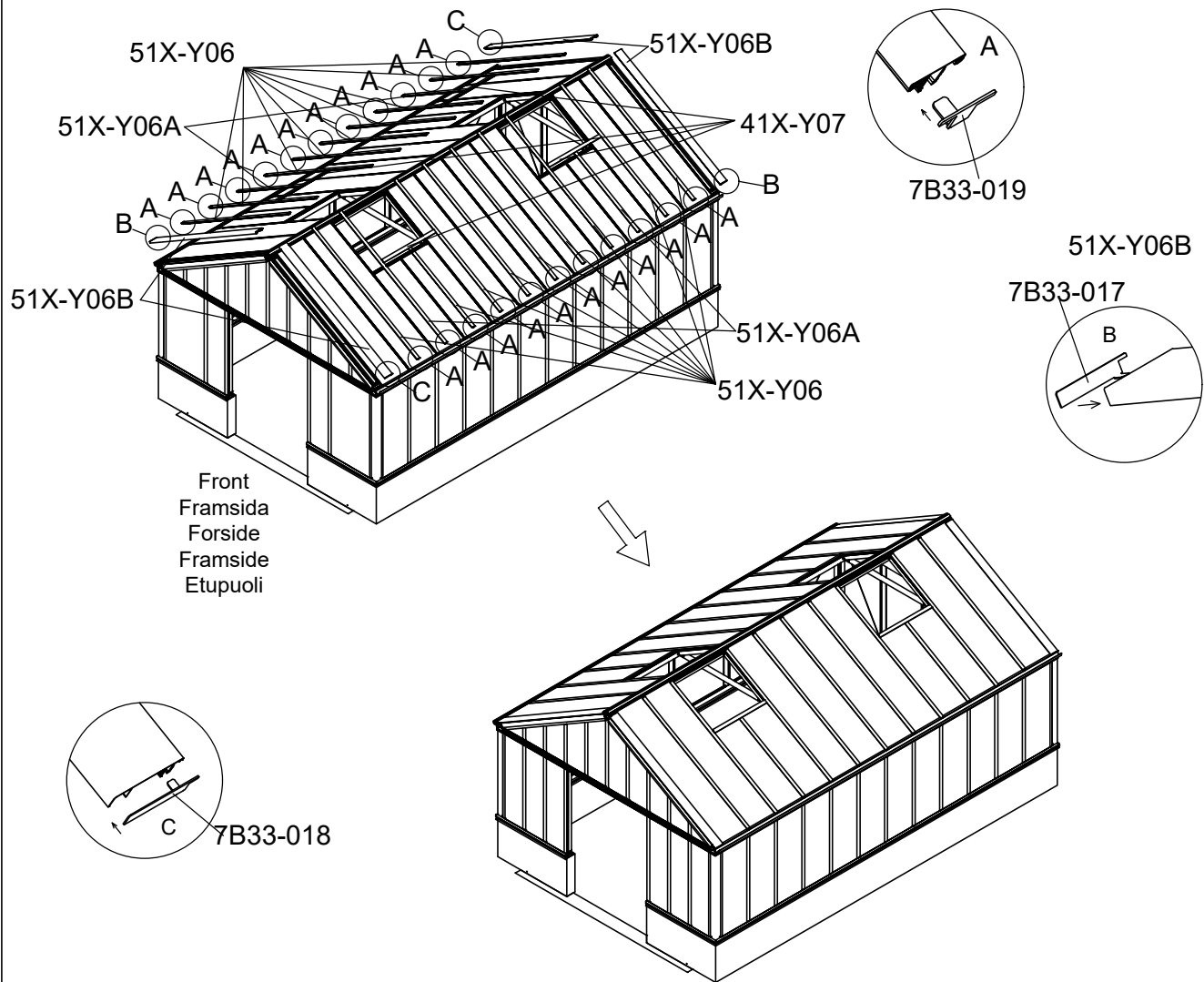

Part	NO.	QTY.									Length (MM)
		3731			3732			3733			
		3731	SH2GA5-EXTN-2	SH2GA5-EXTW-2	3732	SH2GA5-EXTN-2	SH2GA5-EXTW-2	3733	SH2GA5-EXTN-2	SH2GA5-EXTW-2	
	51X-Y06	6	6	0	8	6	0	10	8	0	2216
	51X-Y06A	0	0	2	0	0	4	0	0	4	1334
	51X-Y06B	4	0	0	4	0	0	4	0	0	2216
	41X-Y07	2	0	0	4	0	0	4	0	0	950
	7B33-019	6	6	2	8	6	4	10	8	4	PCS
	7B33-017	2	0	0	2	0	0	2	0	0	PCS
	7B33-018	2	0	0	2	0 <td 0	2	0	0	PCS	

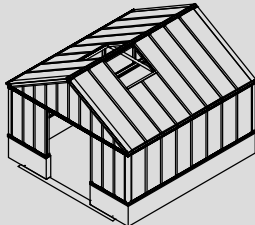
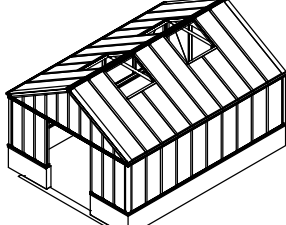
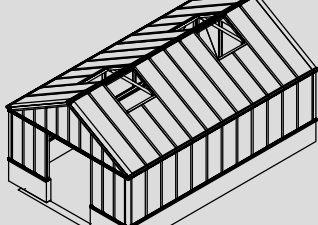







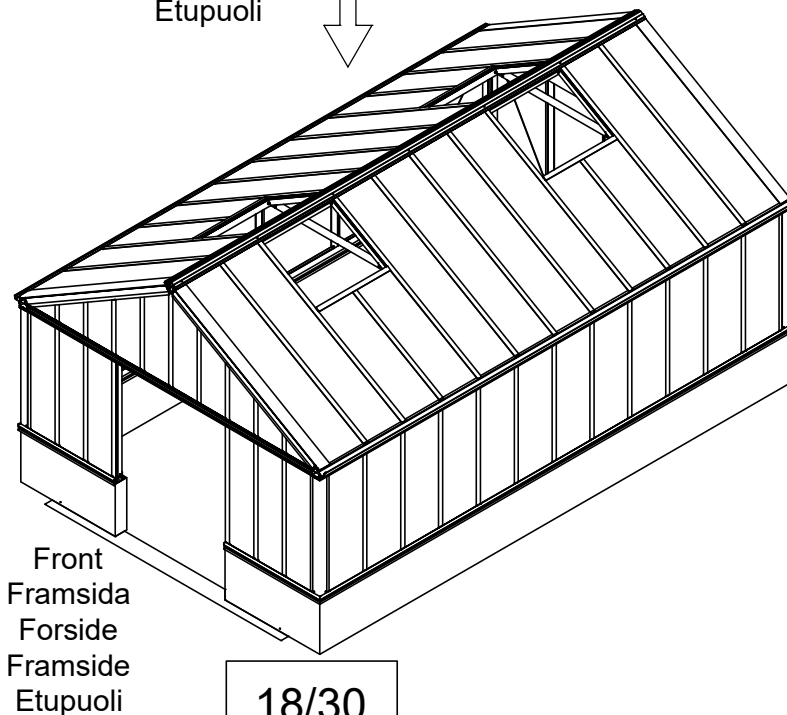
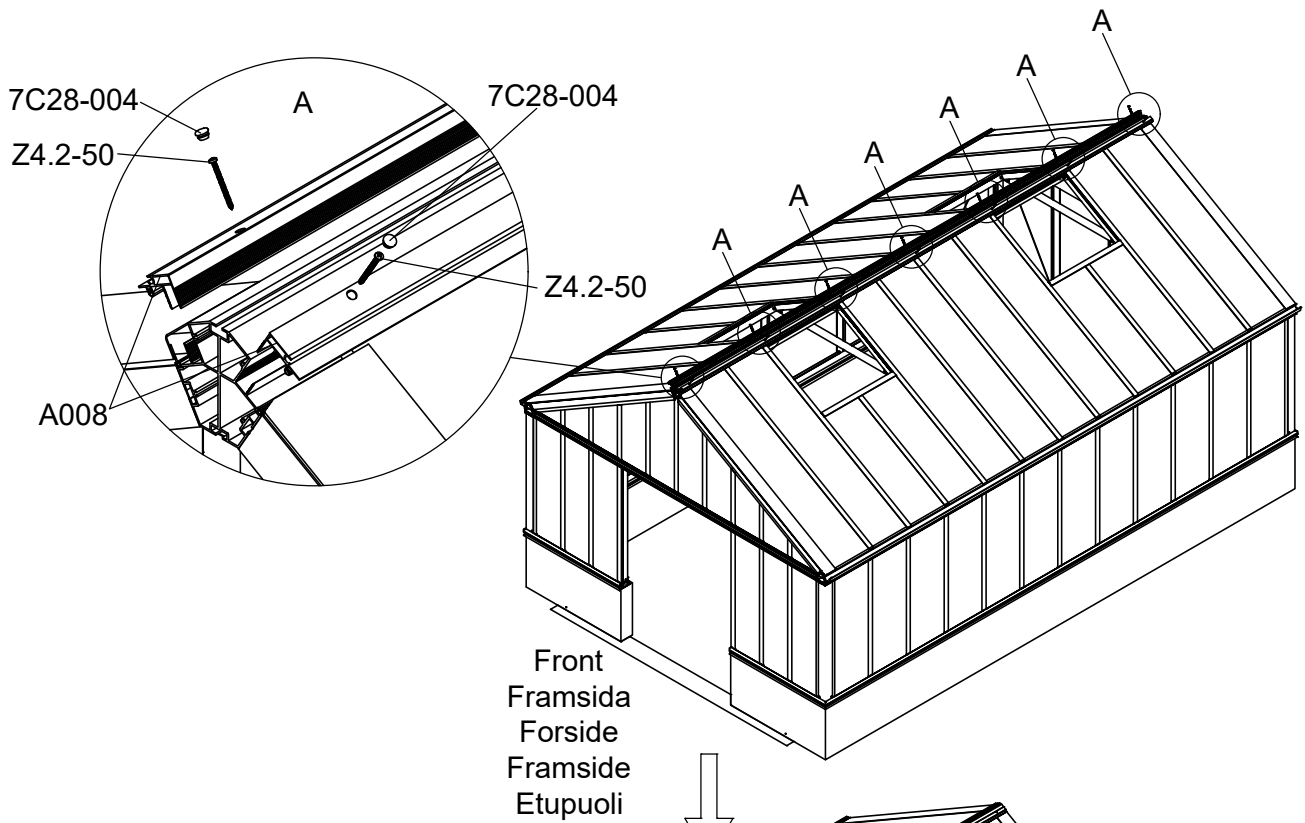

3731	3732	3733
		

17d/30







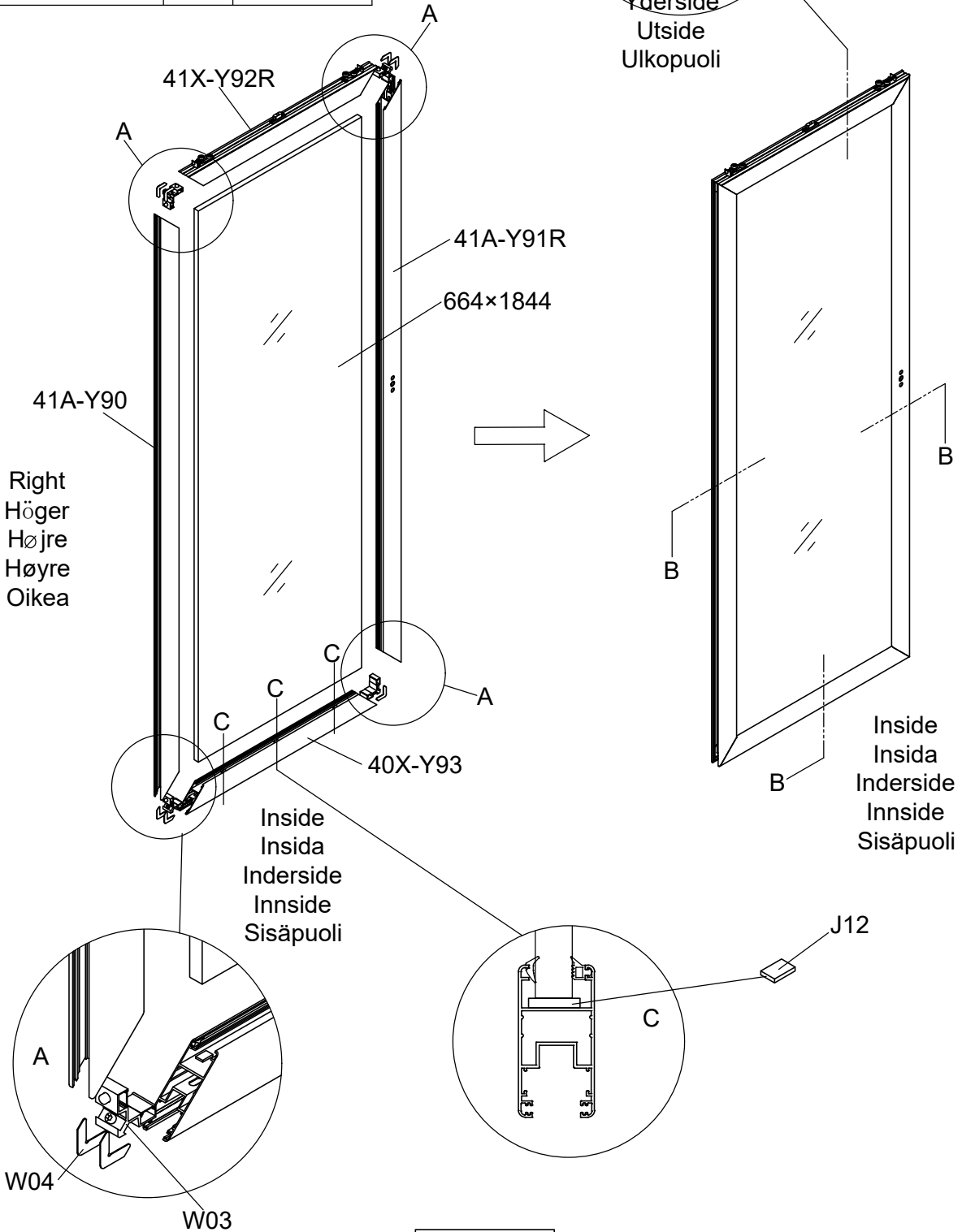
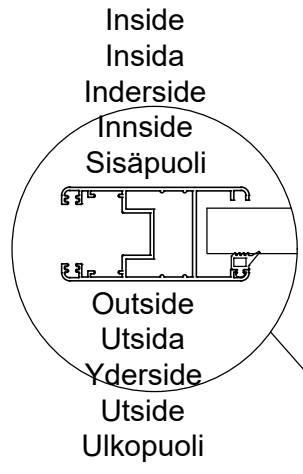

Part	NO.	QTY.			Length(MM)
		3731	3732	3733	
	7C28-004	10	12	14	PCS
	Z4.2-50	10	12	14	PCS

Part	Product	NO.	Length(MM)	QTY.	Code
	3731	41X-Y63-4A	4207	2	A008
	3732	41X-Y63-5A	5208		
	3733	41X-Y63-6A	6209		



Part	NO.	QTY.	Length(MM)
	664×1844	1	1844
	41A-Y90	1	1958
	41A-Y91R	1	1958
	41X-Y92R	1	776
	41X-Y93	1	776
	W03	4	30
	W04	8	PCS
	J12	3	PCS





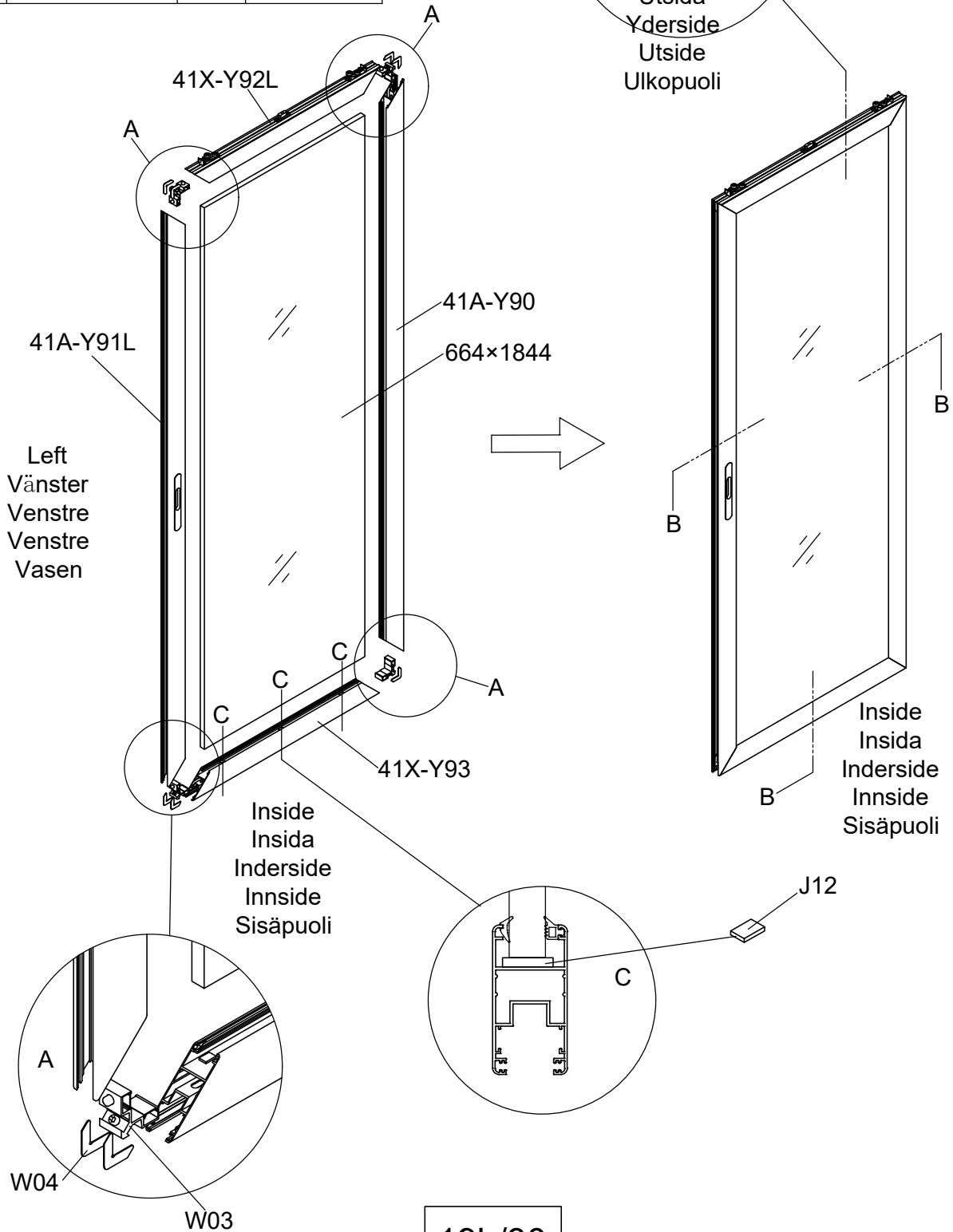
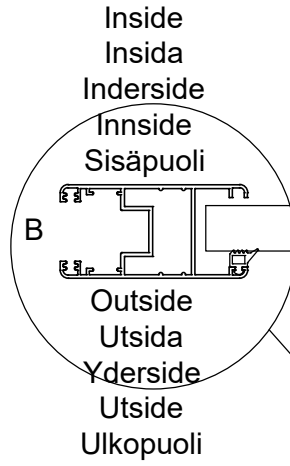

Part	NO.	QTY.	Length(MM)
	664×1844	1	1844
	41A-Y90	1	1958
	41A-Y91L	1	1958
	41X-Y92L	1	776
	41X-Y93	1	776
	W03	4	30
	W04	8	PCS
	J12	3	PCS

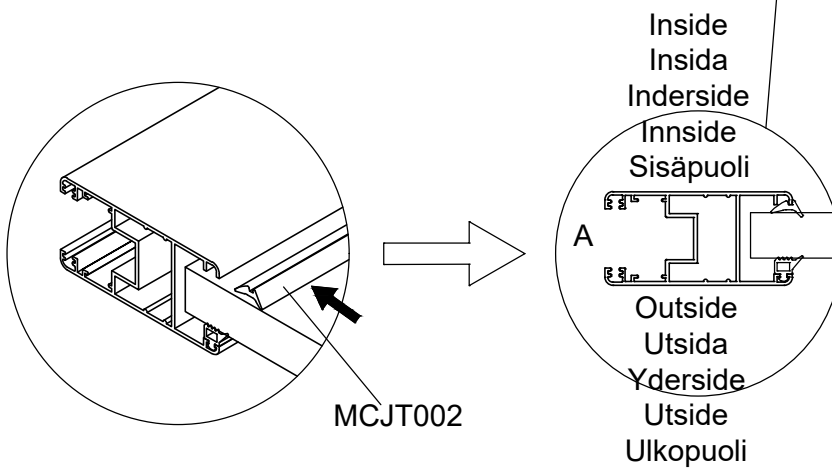
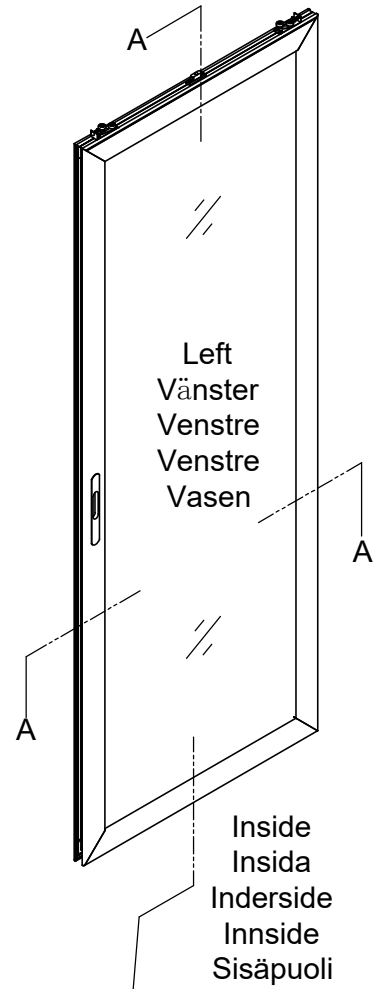
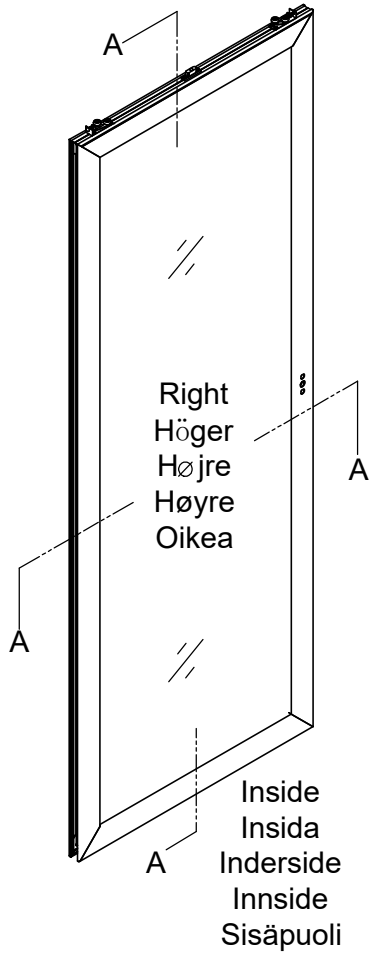





Part	NO.	QTY.	Length(MM)
	MCJT002	12M	

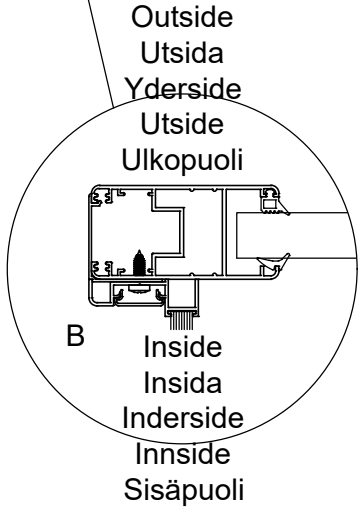
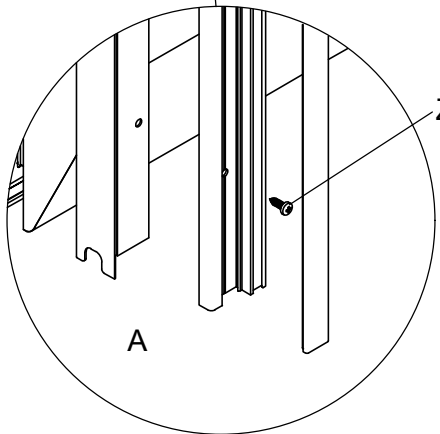
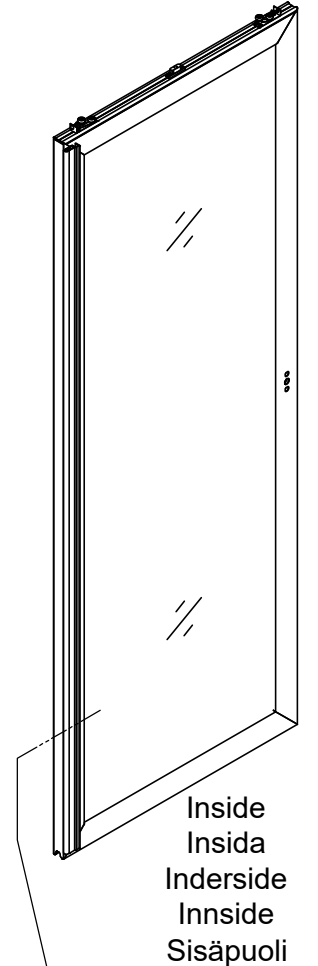
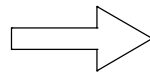
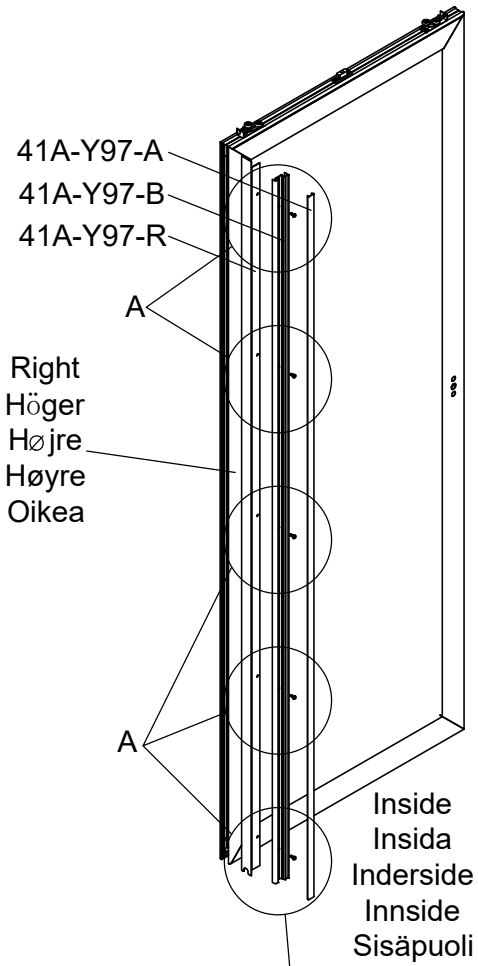





Part	NO.	QTY.	Length(MM)
	41A-Y97-R	1	1951
	41A-Y97-B	1	1918
	41A-Y97-A	1	1918
	Z4.2-13	5	PCS

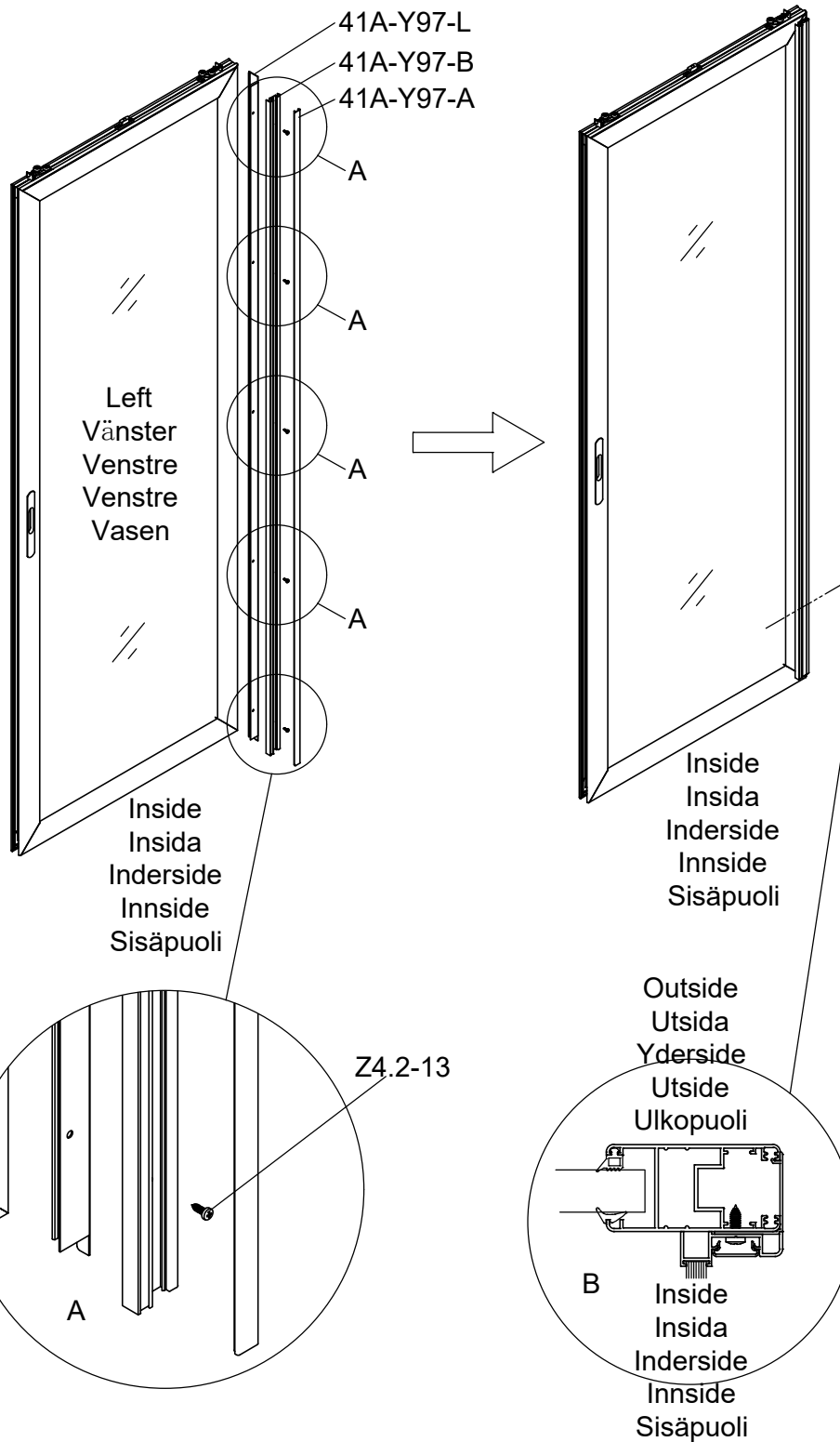





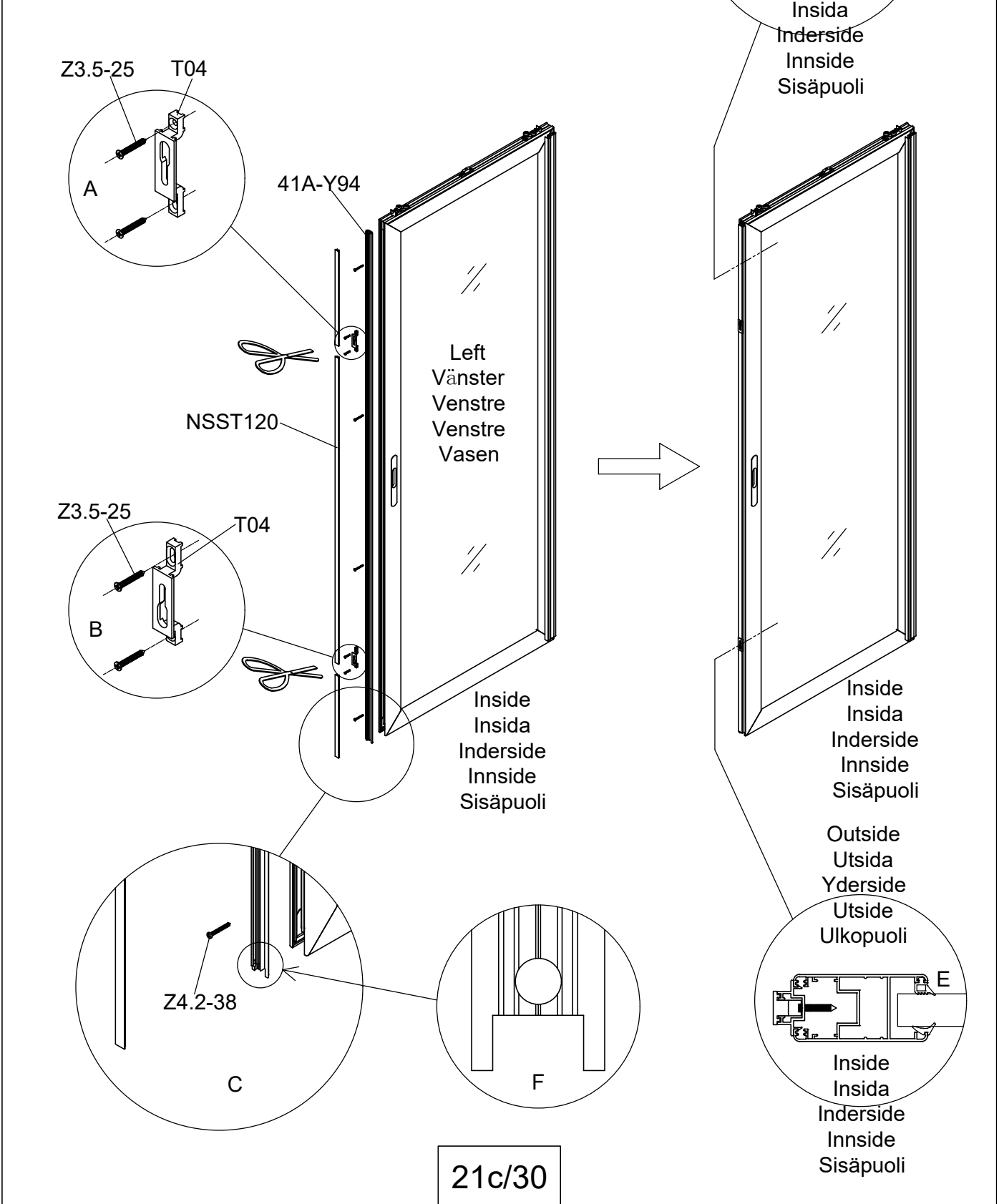

Part	NO.	QTY.	Length(MM)
	41A-Y97-L	1	1951
	41A-Y97-B	1	1918
	41A-Y97-A	1	1918
	Z4.2-13	5	PCS



Part	NO.	QTY.	Length(MM)
	41A-Y94	1	1946
	NSST120	2.0M	
	T04	2	PCS
	Z4.2-38	4	PCS
	Z3.5-25	4	PCS



Part	NO.	QTY.	Length(MM)
	41A-Y98-R	1	2000
	41A-Y98-L	1	2000
	M8-35	2	PCS
	Si8-35	2	PCS
	7B33-020	2	PCS
	Si6-35	4	PCS
	J05	4	PCS

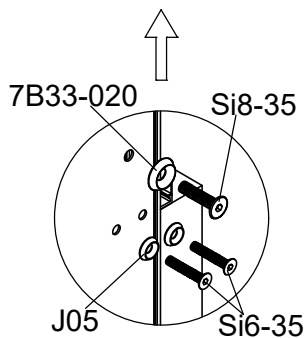
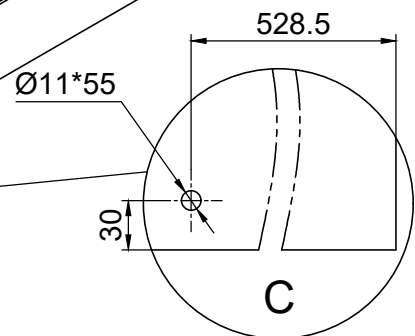
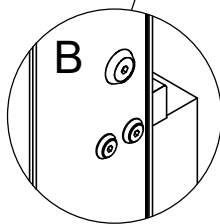
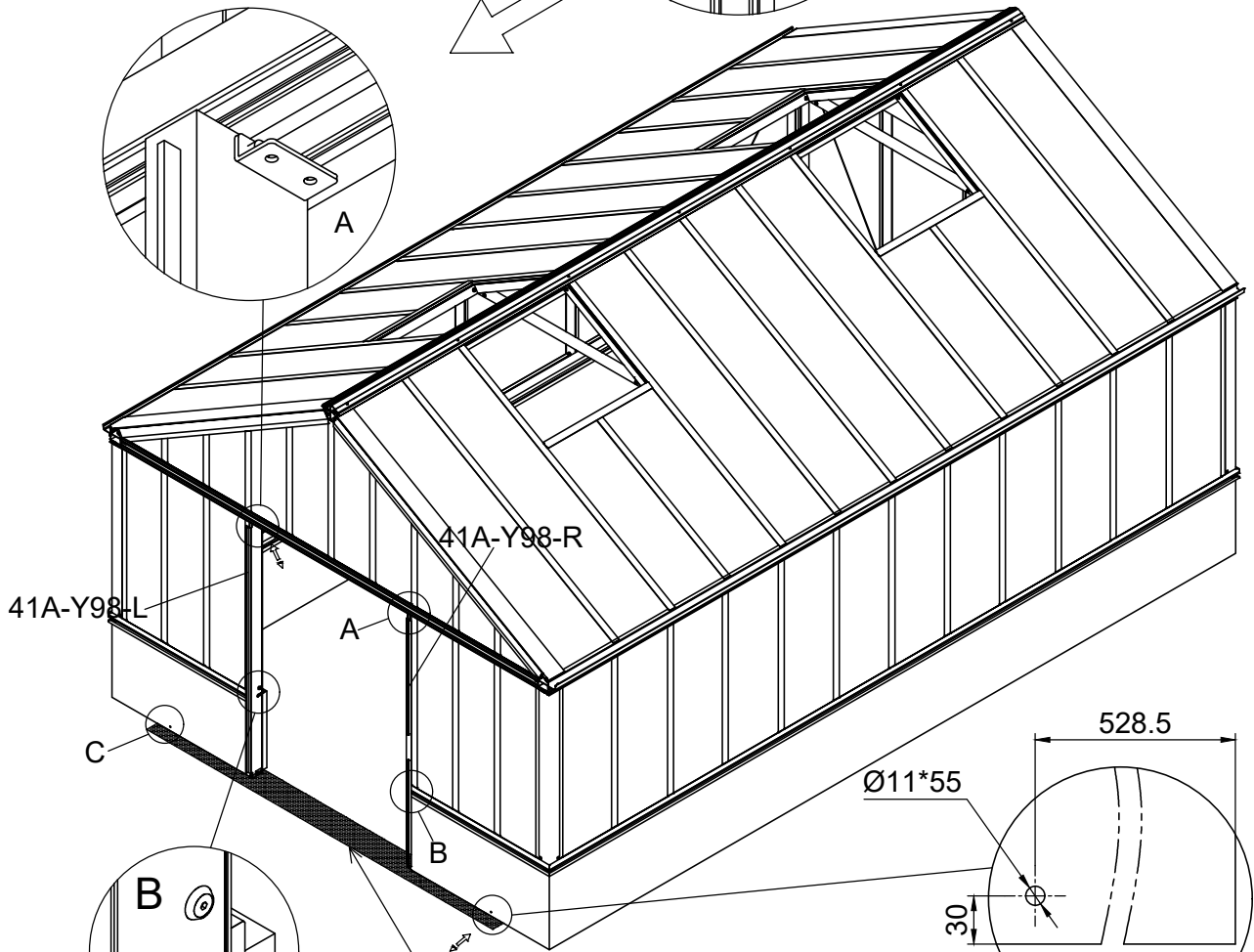
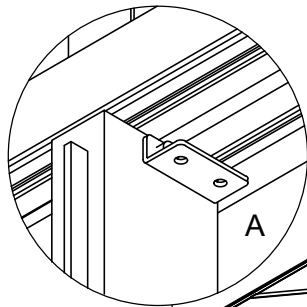
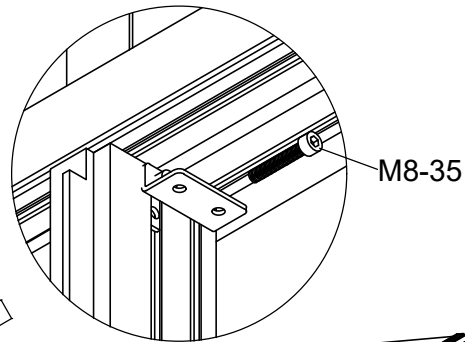

Make sure the floor below the doors frame should be flat and solid.





Se till att underlaget under dörrramen är plan och på solid grund.

Sørg for, at underlaget under dørkarmen er plan og på fast grund.

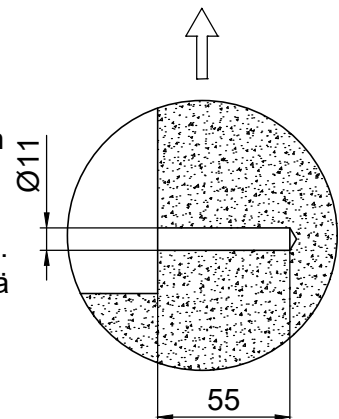



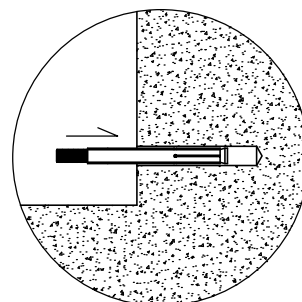
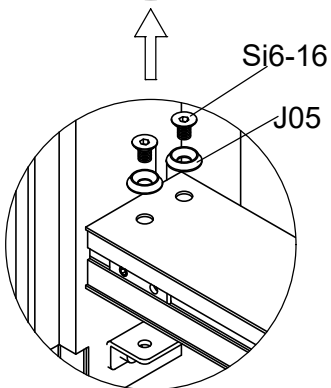
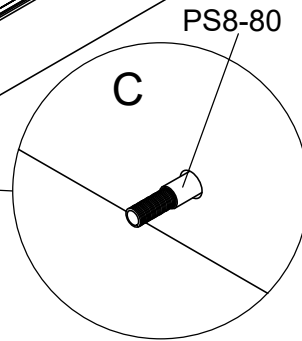
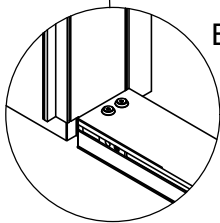
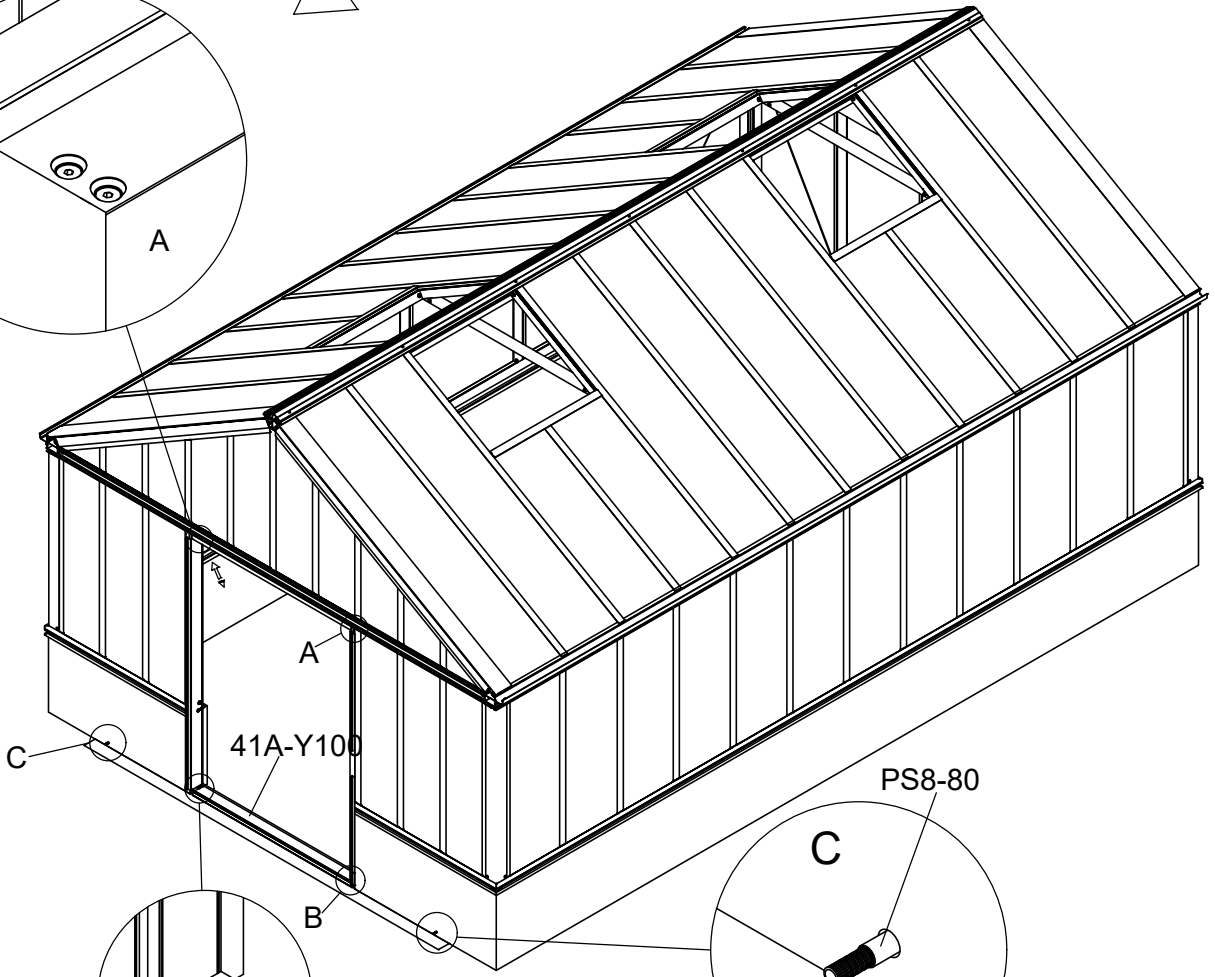
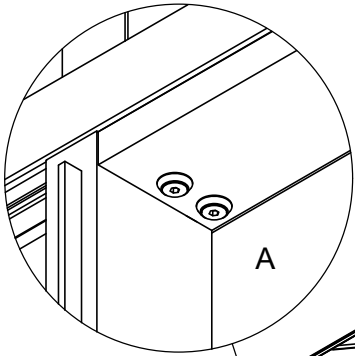
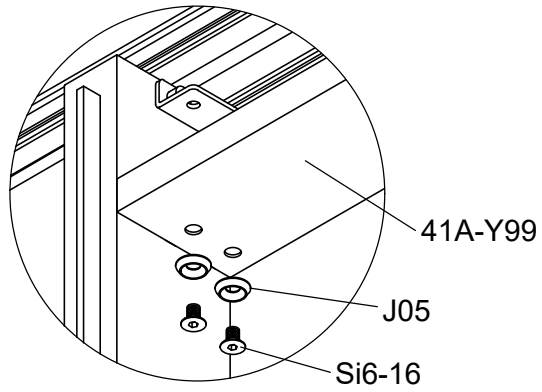

Sørg for at underlaget under dørterskelen er slett og på solid fundament.

Tarkista, että maa ovikarmin alla on sileä ja tasainen.



Part	NO.	QTY.	Length(MM)
	41A-Y99	1	1410
	41A-Y100	1	1410
	Si6-16	8	PCS
	J05	8	PCS
	PS8-80	2	PCS



Part	NO.	QTY.	Length(MM)
	41A-Y64	1	3016
	41A-Y17	1	3120
	7C28-004	5	PCS
	Z4.2-50	5	PCS
	Si8-25	3	PCS
	7B33-020	3	PCS
	7C26-031	2	PCS

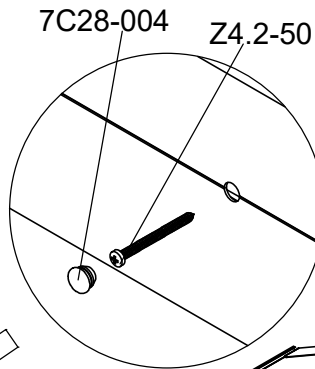

41A-Y64

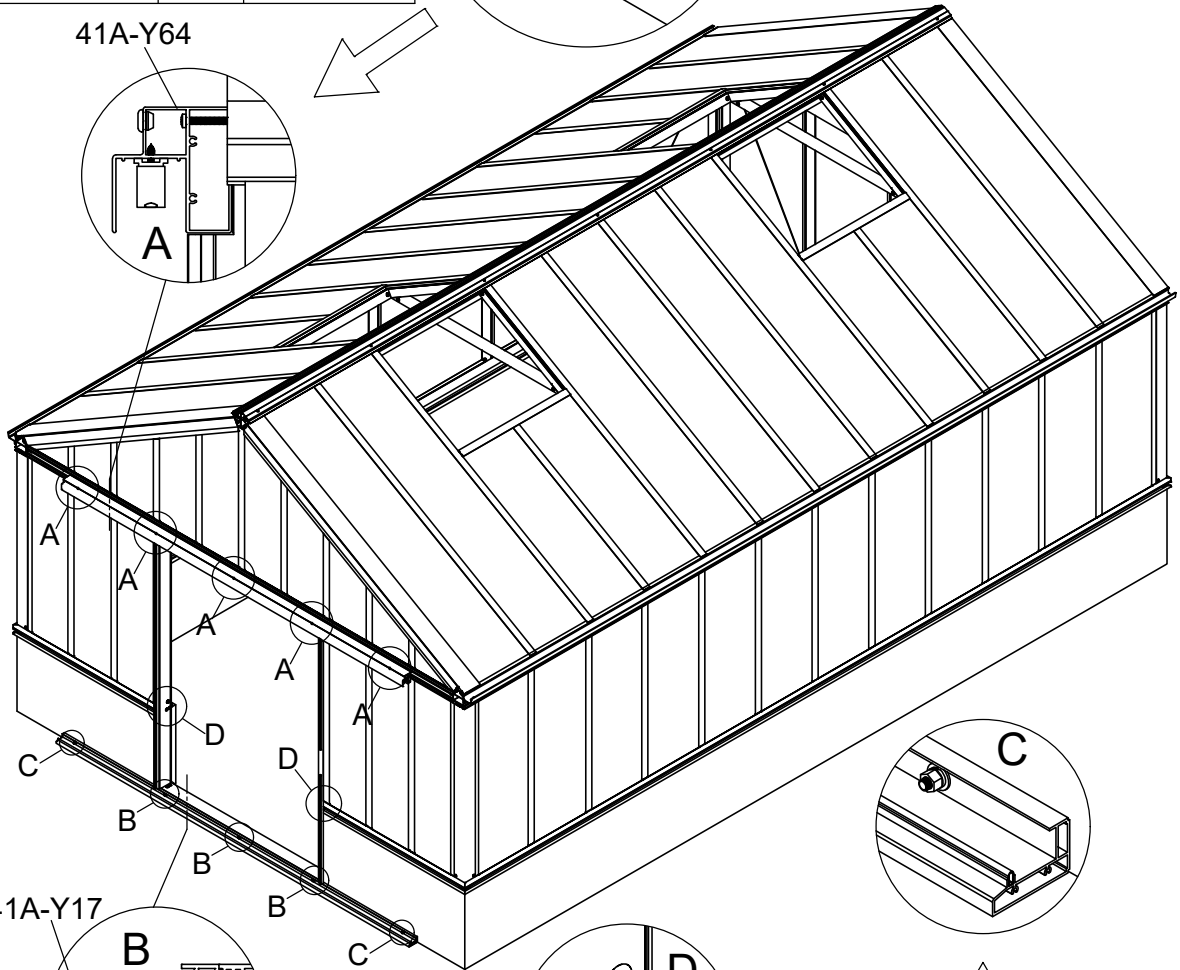
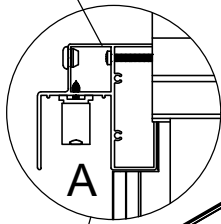

41A-Y17

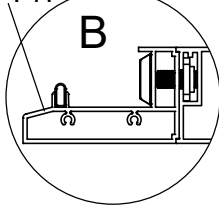

Si8-25

7B33-020

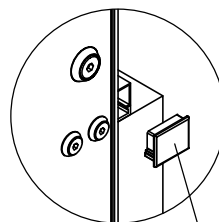
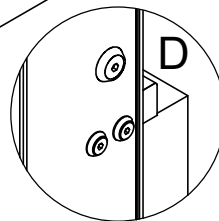
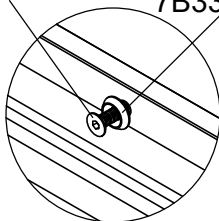

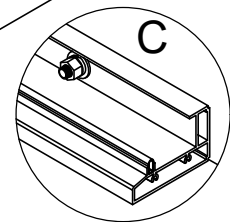

7C26-031

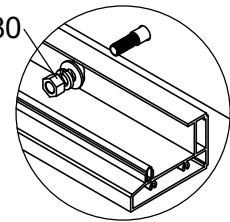

PS8-80



23a/30

Part	NO.	QTY.	Length(MM)
	41A-Y98A-R	1	1923
	41A-Y98A-L	1	1923

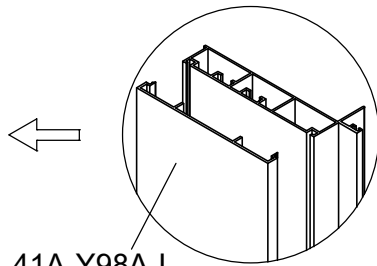
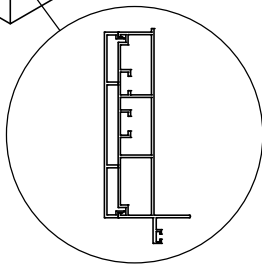
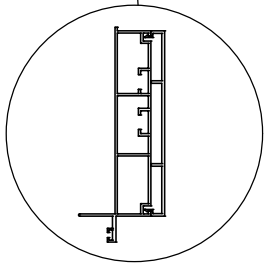
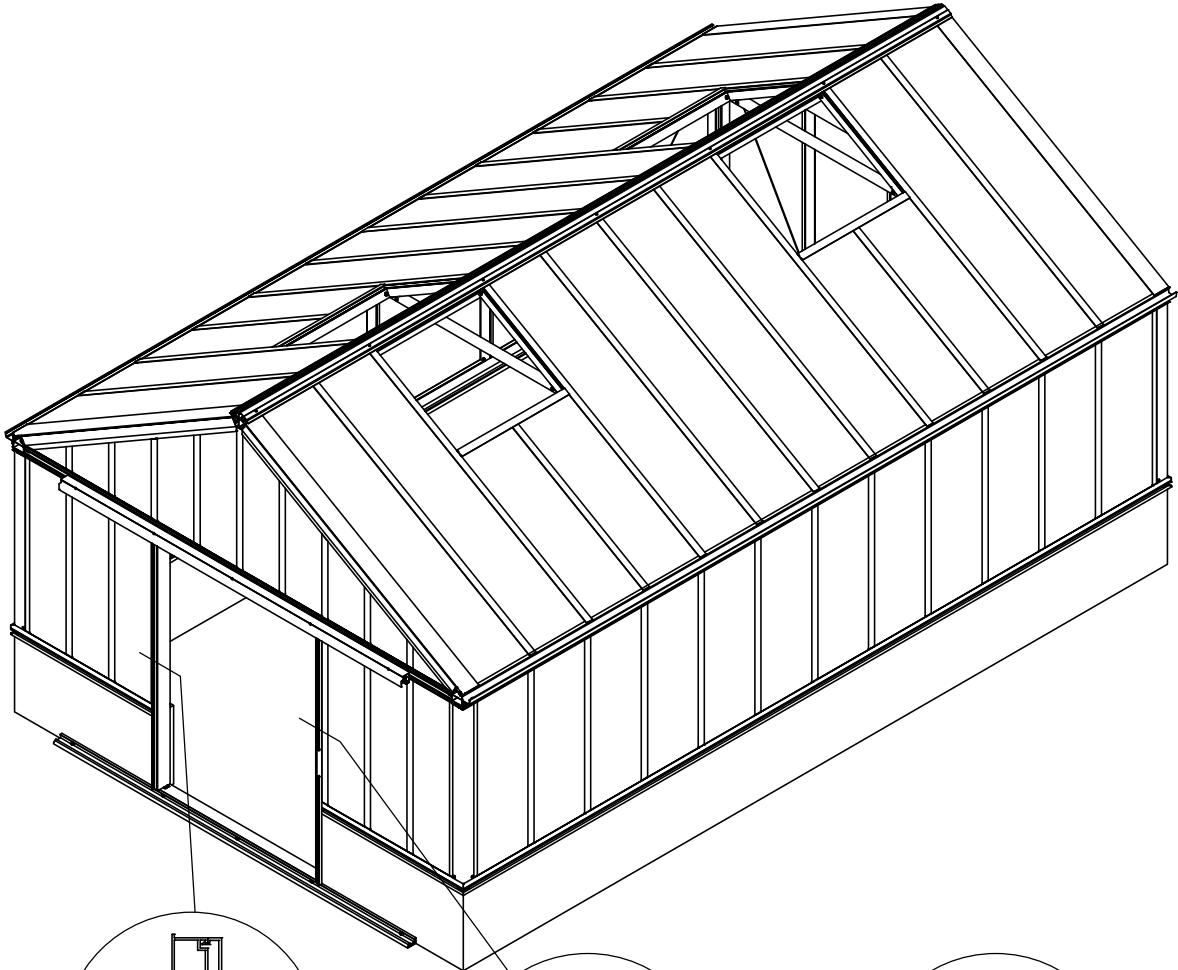

41A-Y98A-L

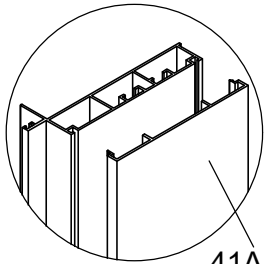



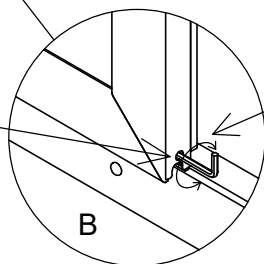
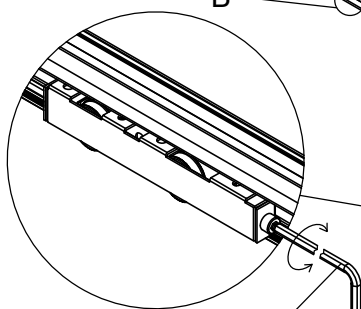
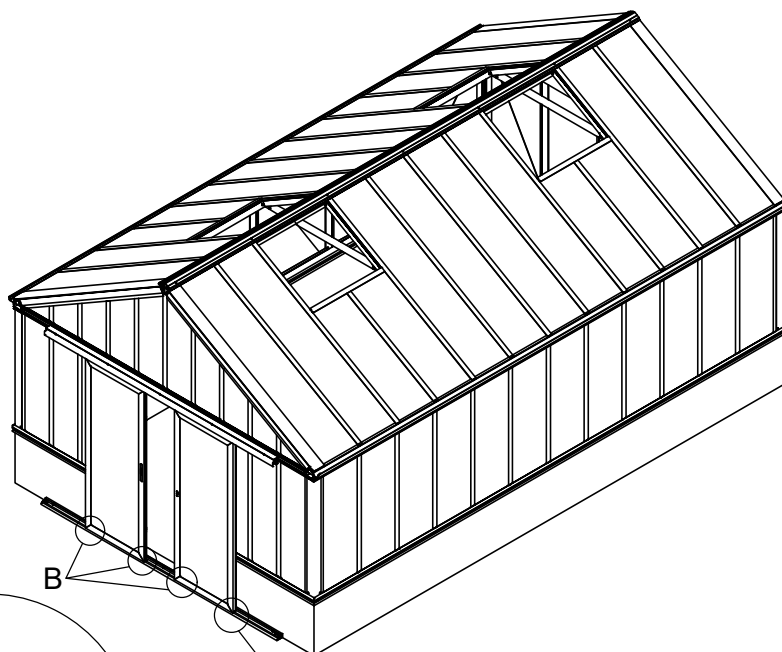
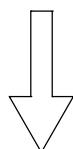
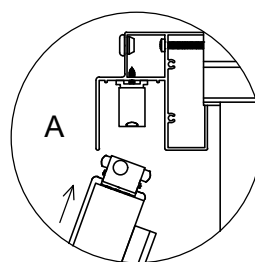
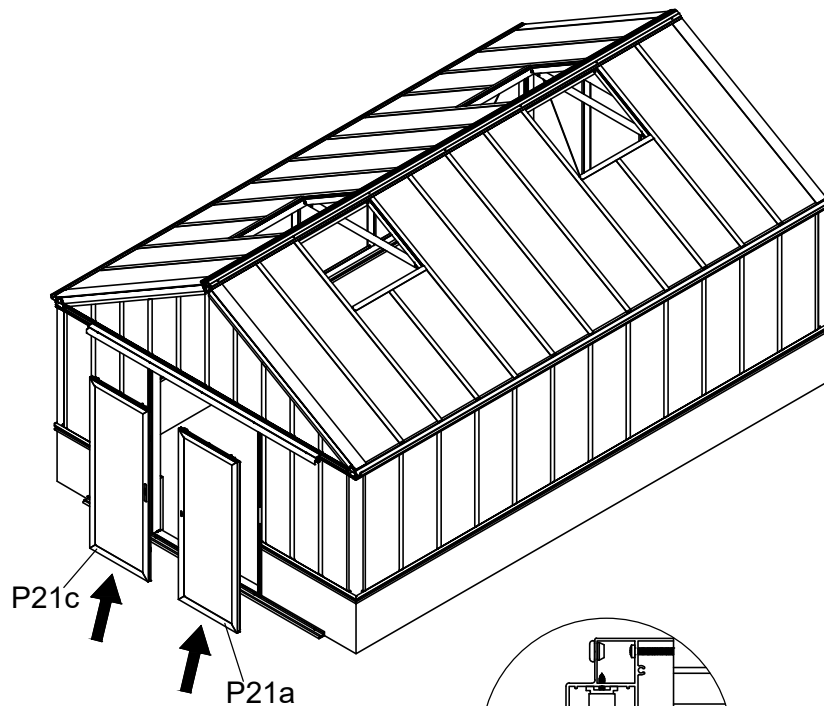







41A-Y98A-L



Adjust the height of the wheels
 Justera höjden för hjulen
 Juster højden af hjulene
 Justere høyden for hjulene
 Säädä alapyörien korkeus





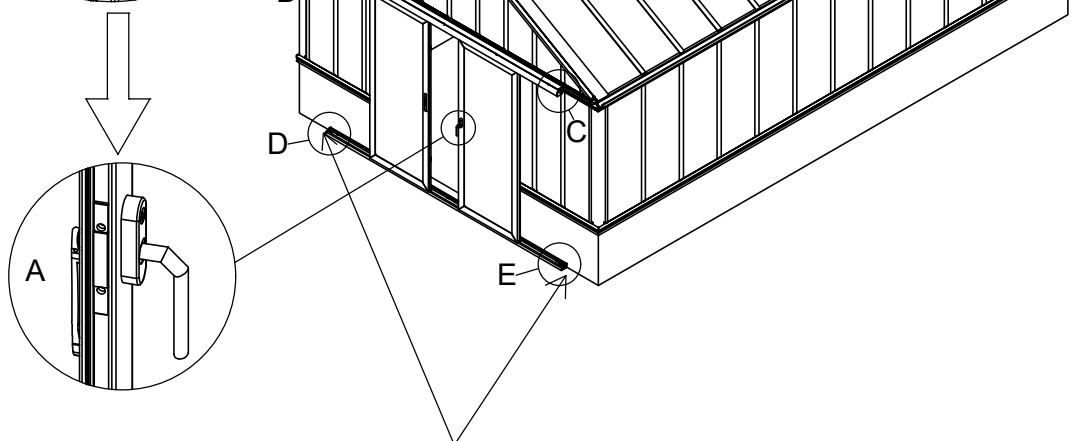
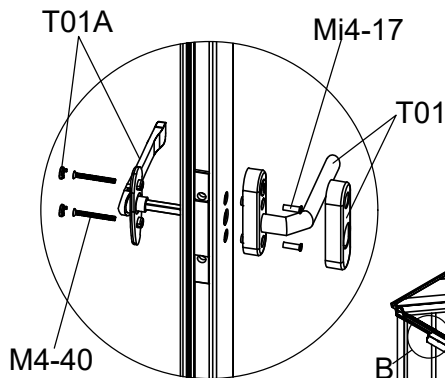
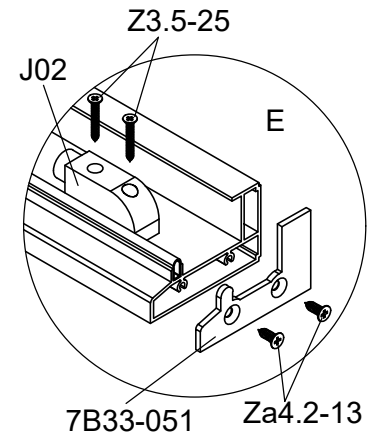
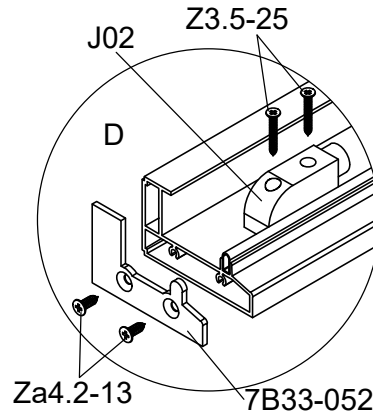
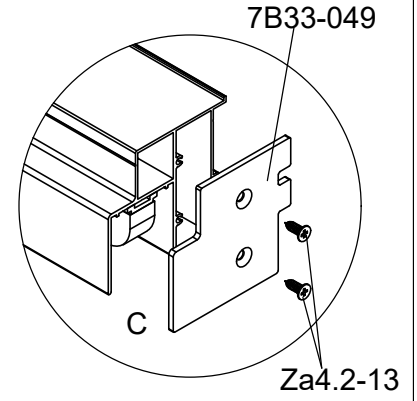
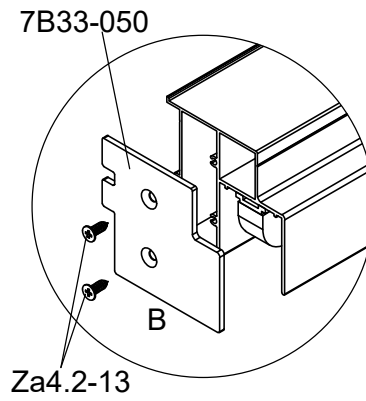

Tool
 Verktyg
 Værktøj
 Verktøy
 Työkalu

23c/30



Part	NO.	QTY.	Length(MM)
	T01	1	PCS
	T01A	1	PCS
	J02	2	PCS
	7B33-049	1	PCS
	7B33-050	1	PCS
	7B33-051	1	PCS
	7B33-052	1	PCS
	M4-40	2	PCS
	Mi4-17	2	PCS
	Z3.5-25	4	PCS
	Za4.2-13	8	PCS

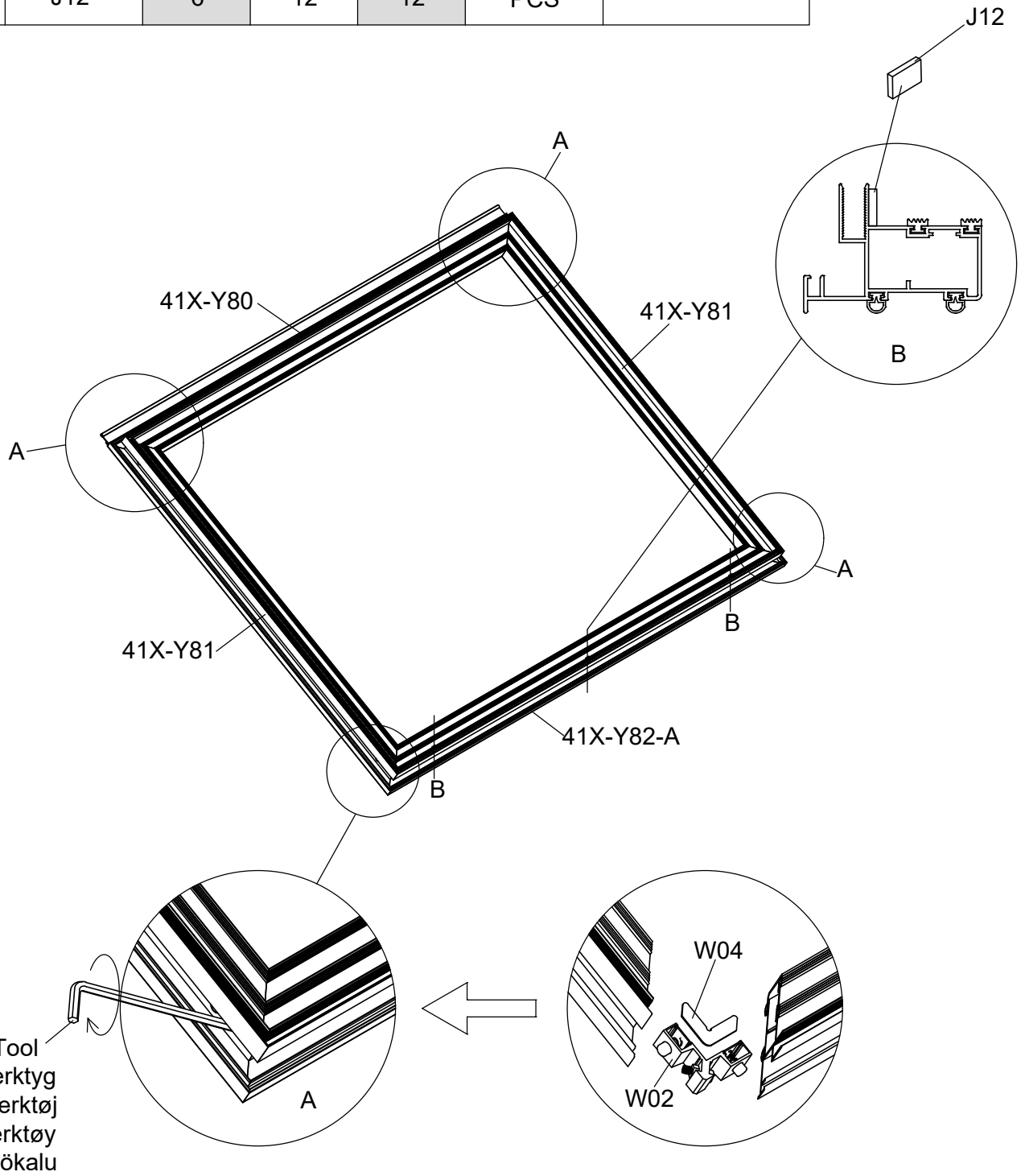

Adjust these door stoppers sideways if you want to open the door larger.
 Justera avstånden av dörrstoppen i sidled om ni vill kunna öppna dörrarna ännu mer.
 Justere dørstopperne sidelæns, for at give større åbning af døren.
 Juster avstanden av dørstopperen sideveis om du vil kunne åpne døren ennå mer.
 Säädä liukuovien stoppareiden etäisyys sivusuunnassa, mikäli haluat ovien avautuvan enemmän.

Part	NO.	QTY.			Length(MM)	CTN NO.
		3731	3732	3733		
	41X-Y80	2	4	4	1087	
	41X-Y81	4	8	8	887	
	41X-Y82-A	2	4	4	1087	SH2GA5-EXTW-2
	W02	8	16	16	PCS	
	W04	8	16	16	PCS	
	J12	6	12	12	PCS	



Part	NO.	QTY.			Length(MM)
		3731	3732	3733	
	41X-Y83	4	8	8	887
	41X-Y84	4	8	8	1076
	1032x831	2	4	4	950

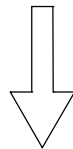
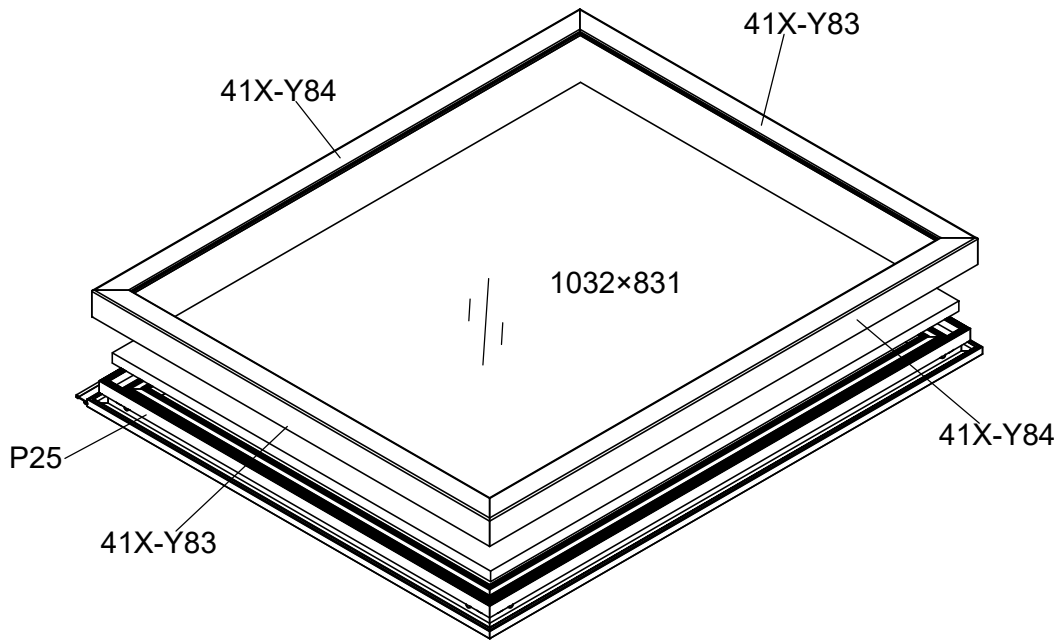

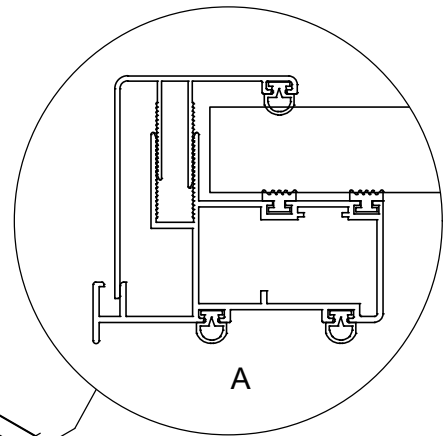
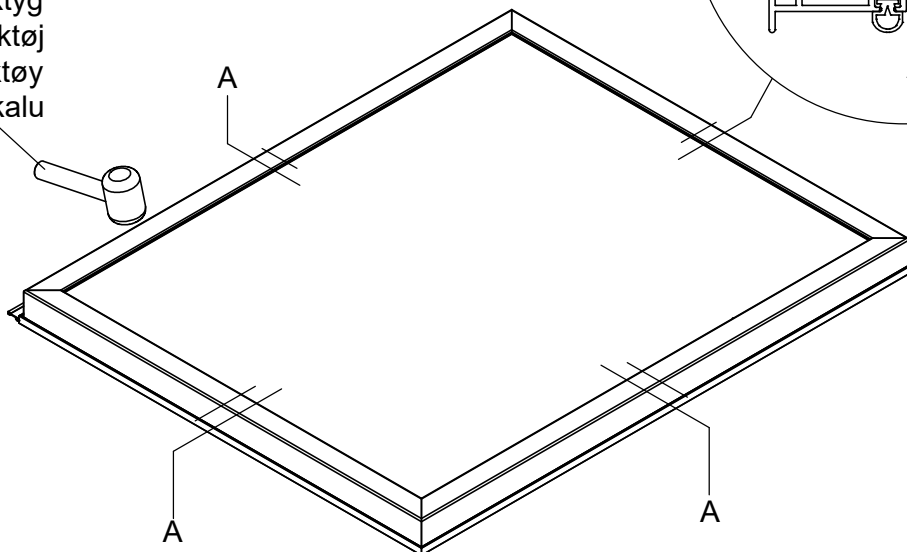

Tool
 Verktøy
 Værktøj
 Verktøy
 Työkalu

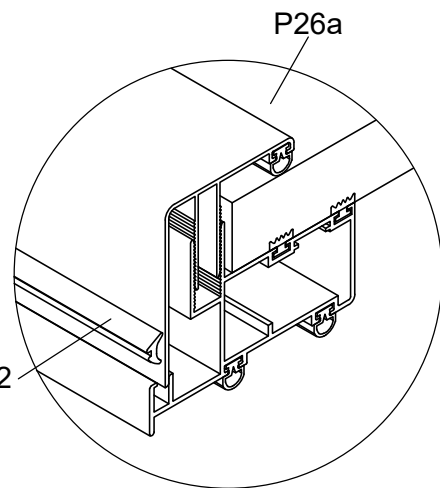
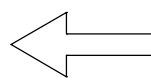
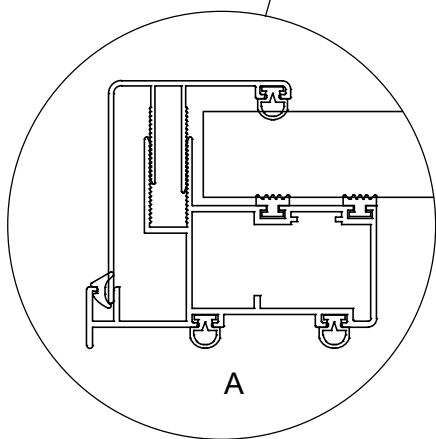
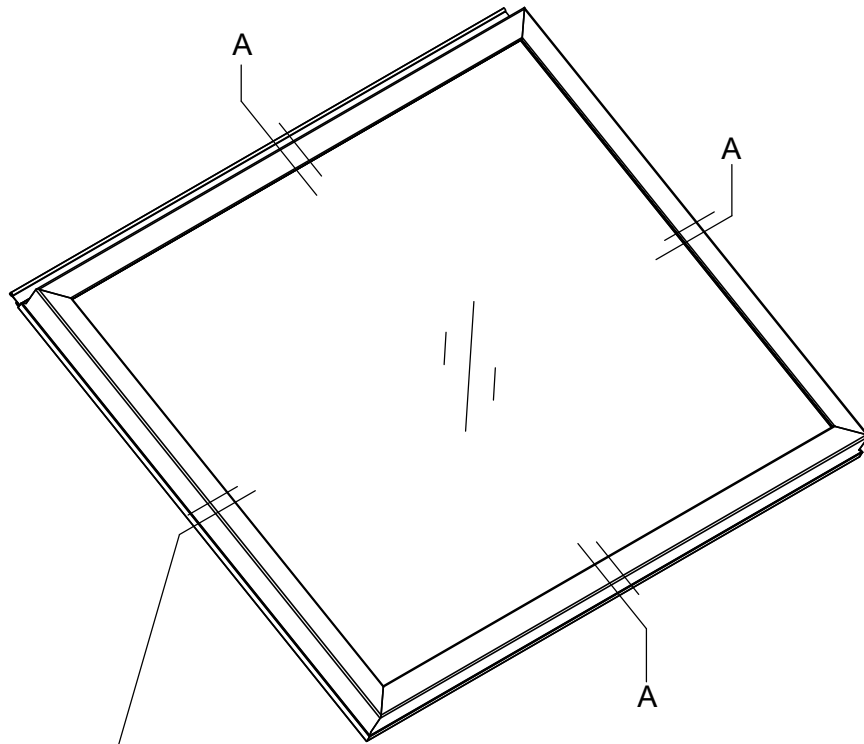

25b/30

Part	NO.	QTY.			Length(MM)
		3731	3732	3733	
	7C26-022	8.5M	17M	17M	



Part	NO.	QTY.			Length(MM)
		3731	3732	3733	
	T07	4	4	4	PCS

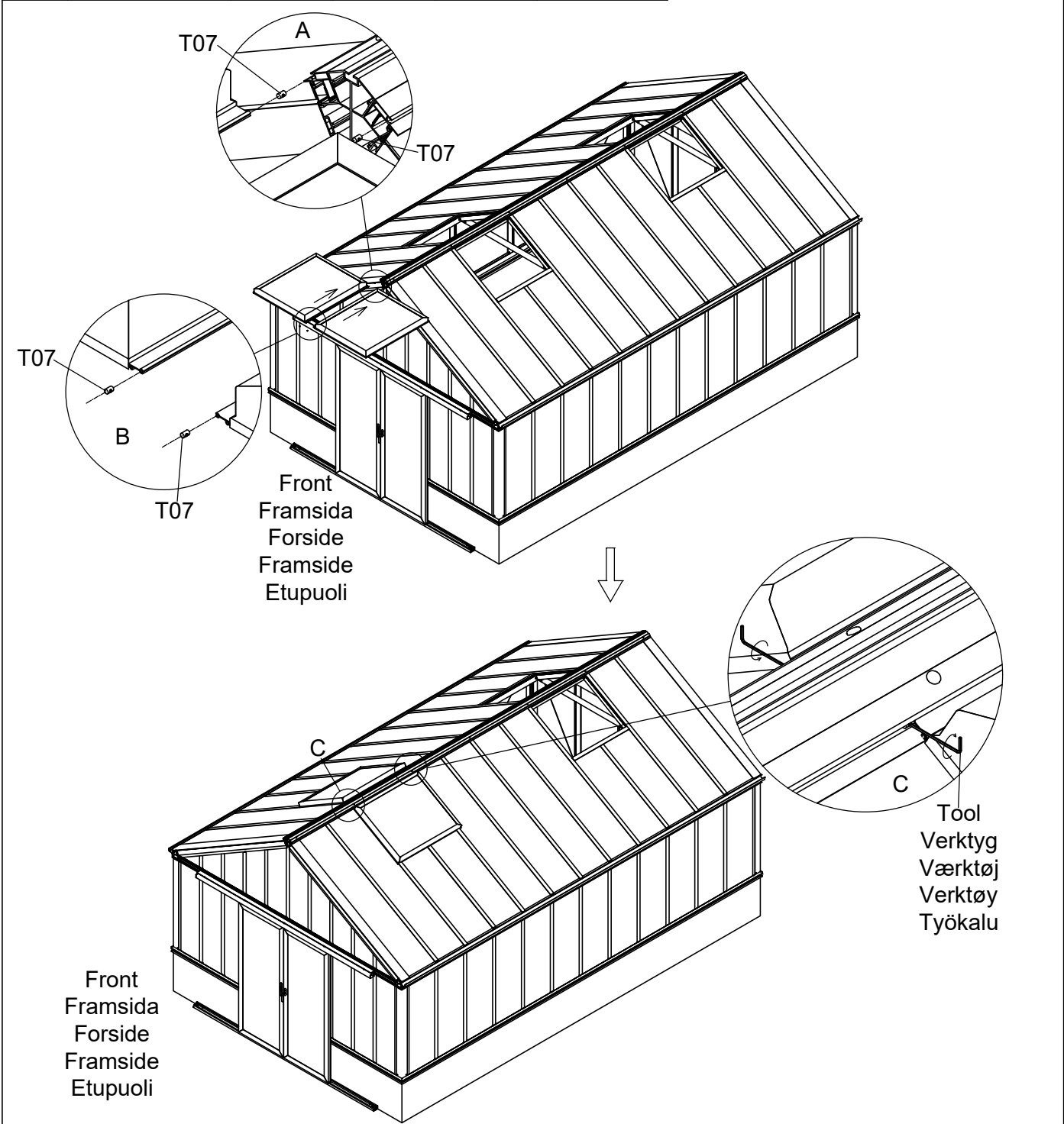

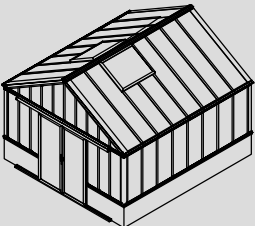
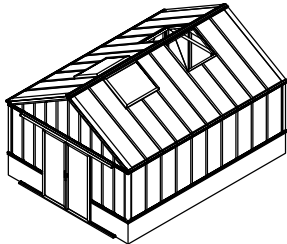
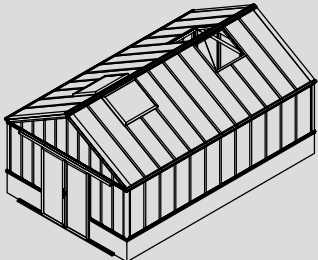

3731	3732	3733
		

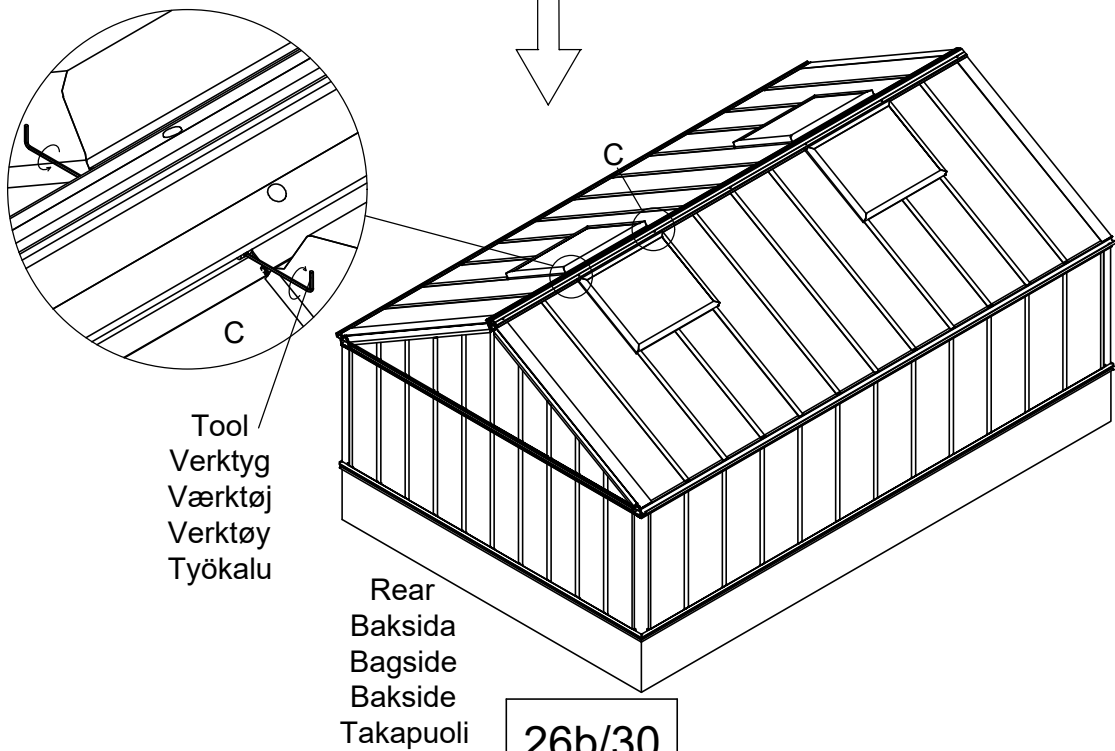
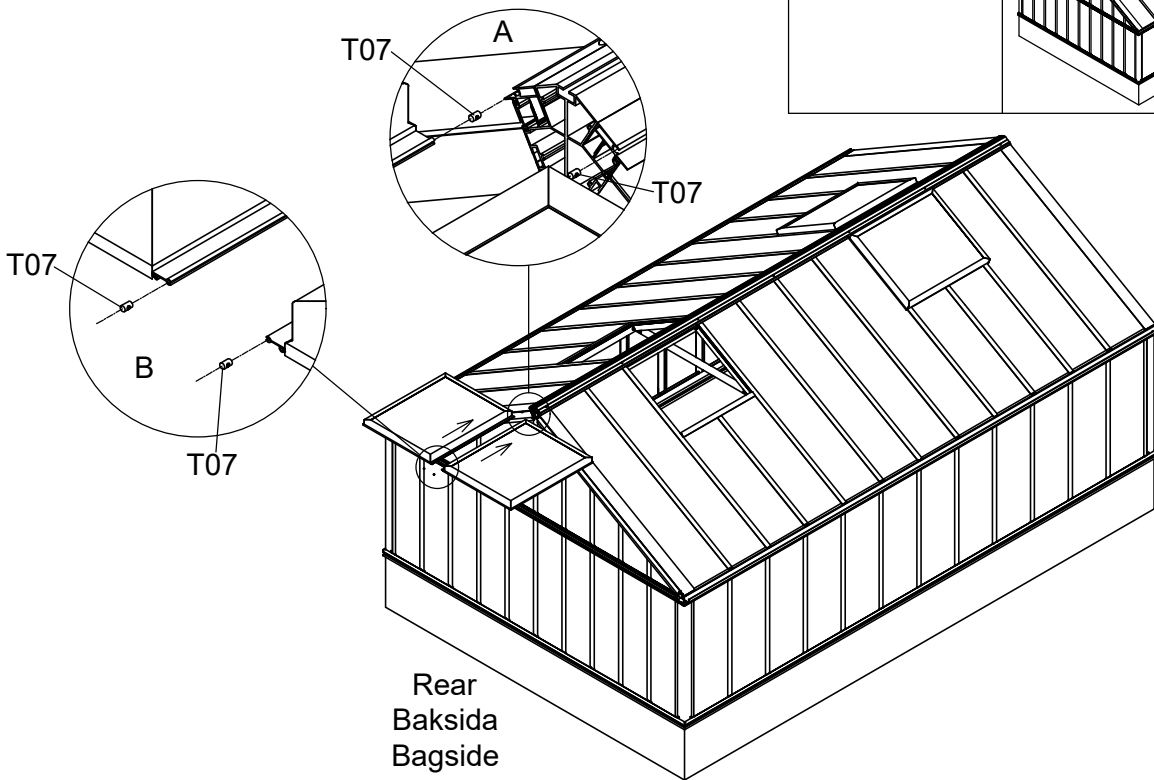
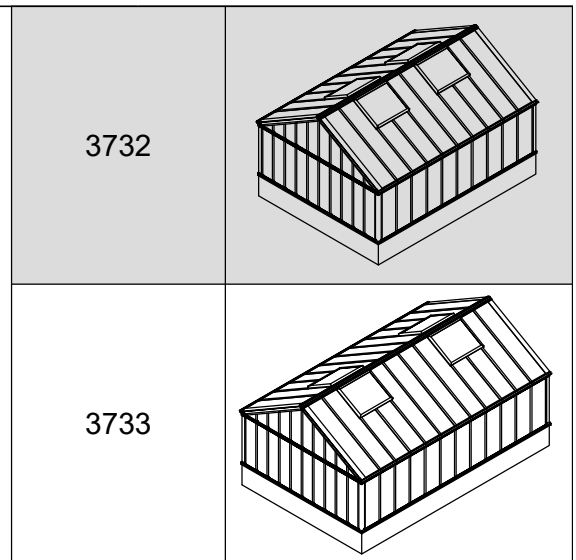
Part	NO.	QTY.		Length(MM)
		3732	3733	
	T07	4	4	PCS



26b/30

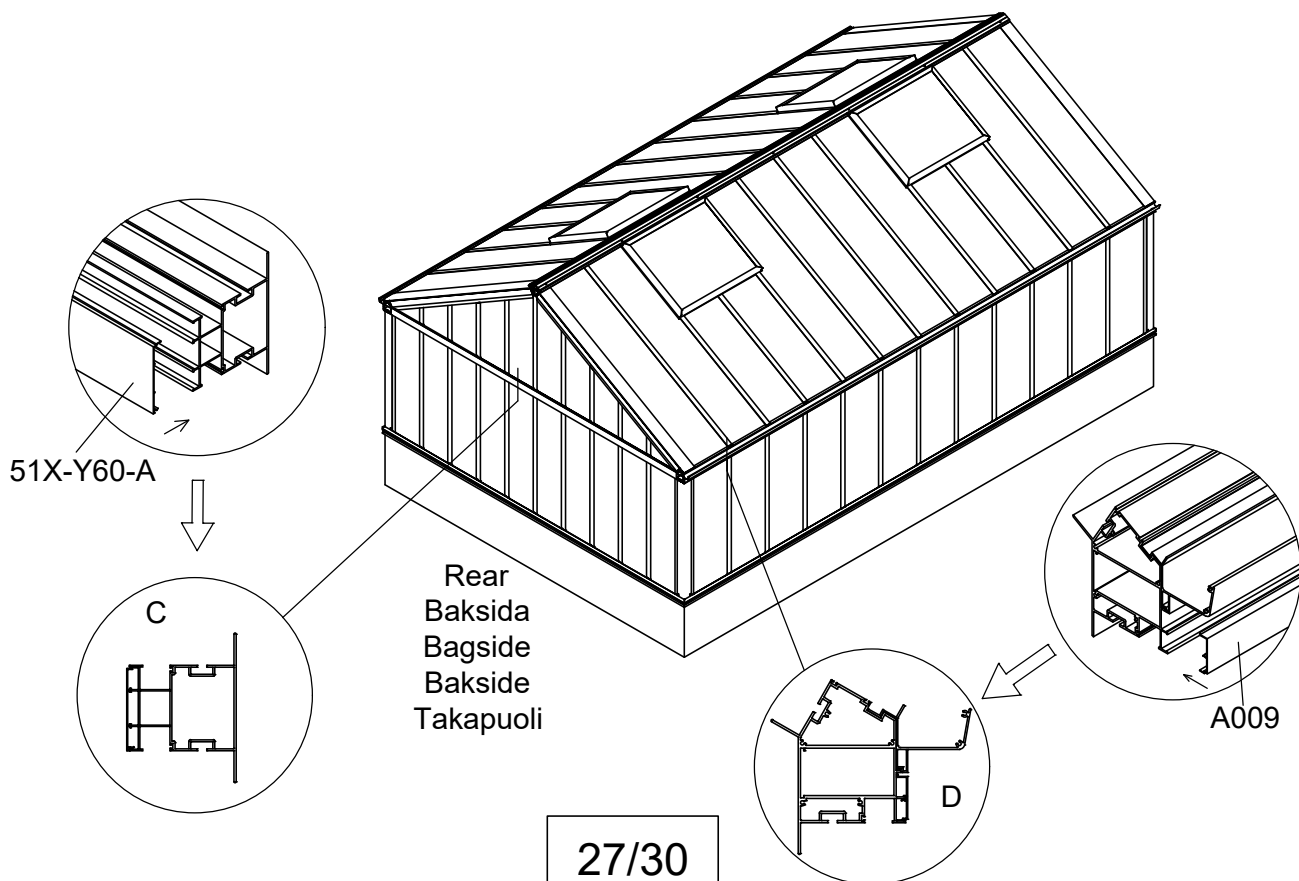
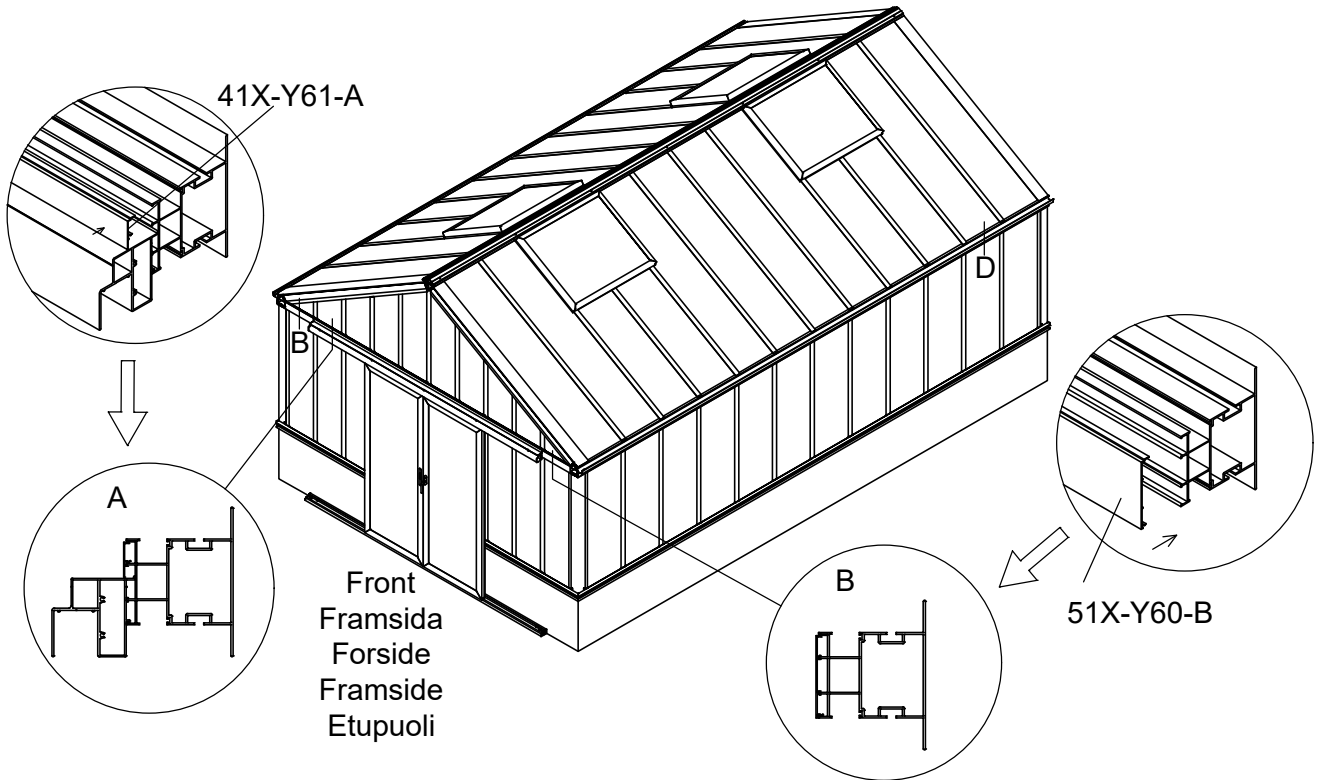

Part	NO.	QTY.	Length(MM)
	41X-Y61-A	1	3023
	51X-Y60-A	1	3774
	51X-Y60-B	2	375

Part	Product	NO.	Length(MM)	QTY.	Code
	3731	41X-Y62-4A	4228		
	3732	41X-Y62-5A	5229	2	A009
	3733	41X-Y62-6A	6230		

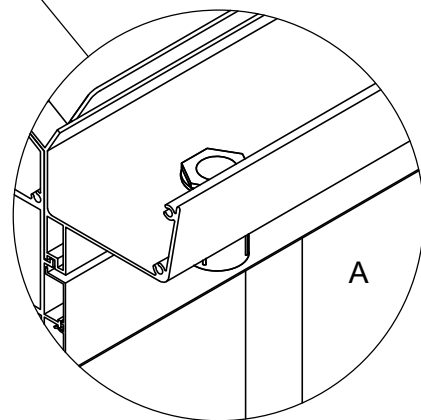
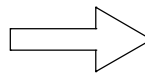
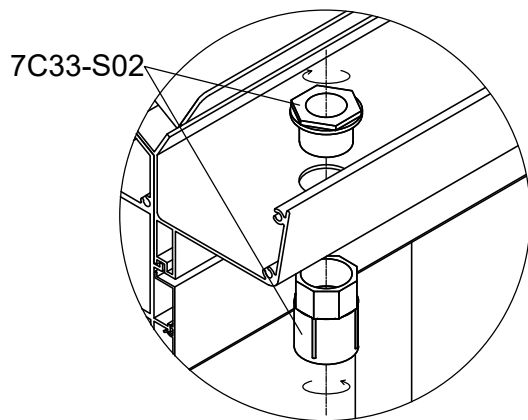
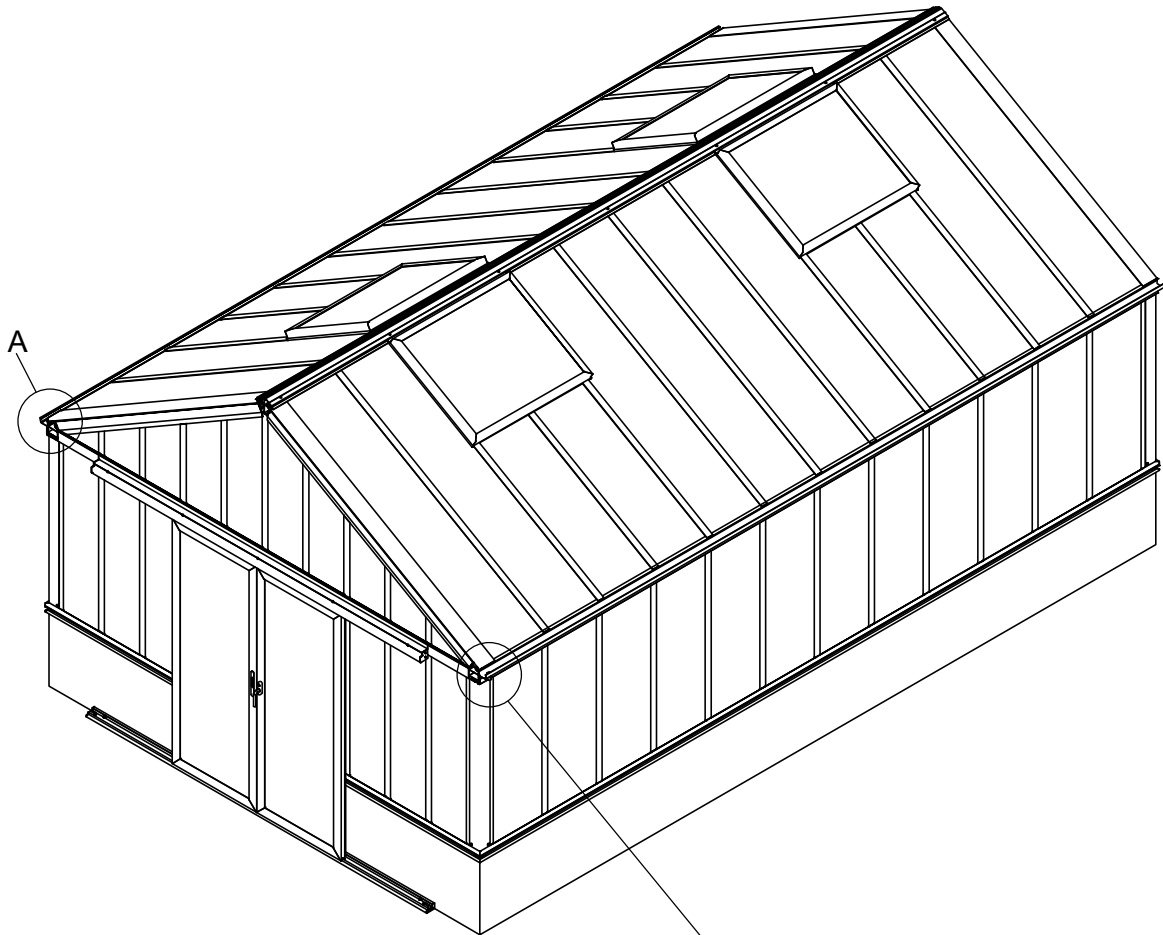

Part	NO.	QTY.	Length(MM)
	7C33-S02	2	PCS



Part	NO.	QTY.	Length(MM)
	7C33-S01	2	1980
	7C33-S03	4	PCS
	Z4.8-25	4	PCS

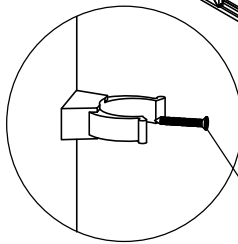
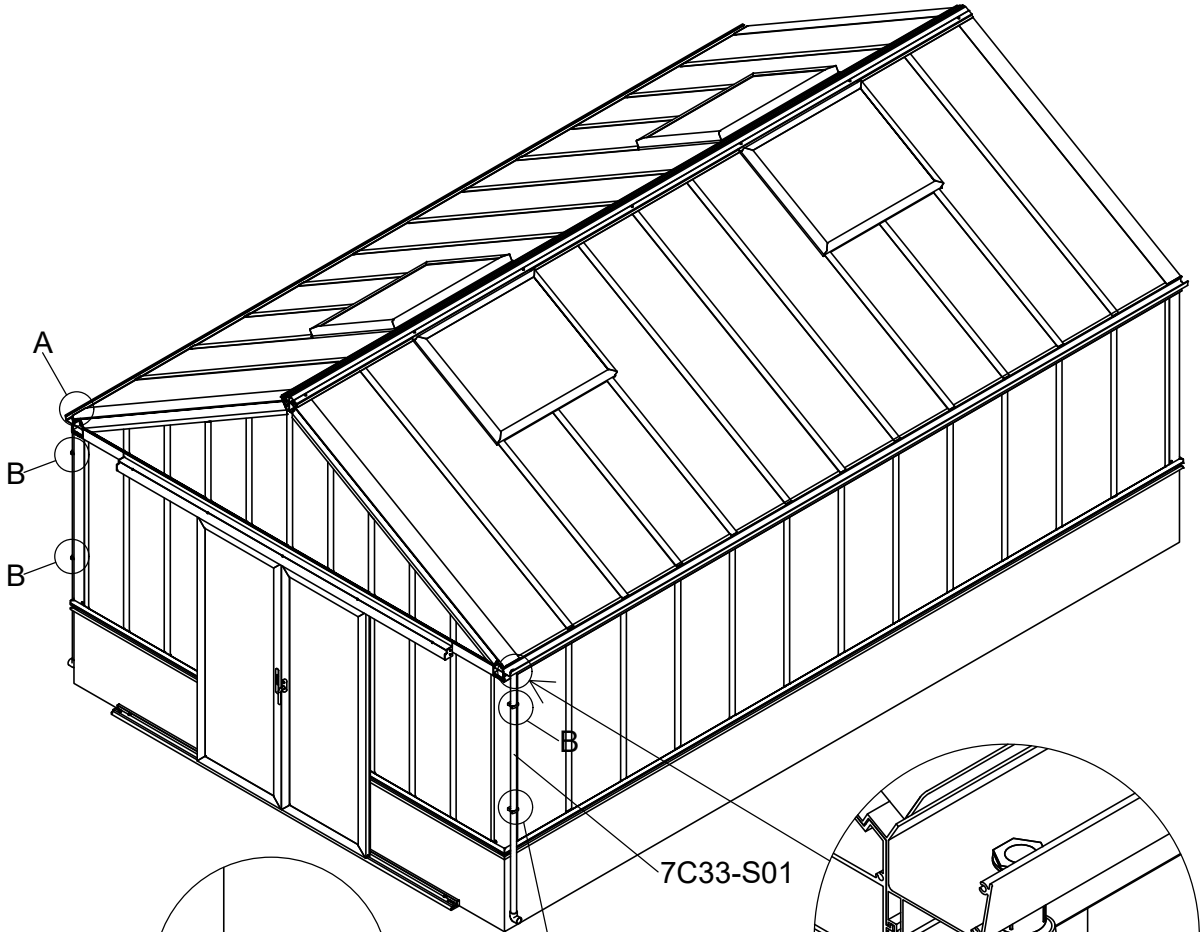

Z4.8-25

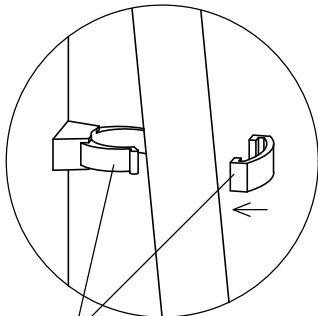



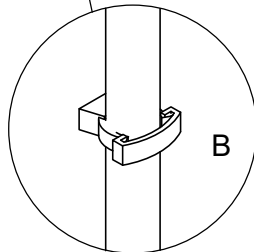

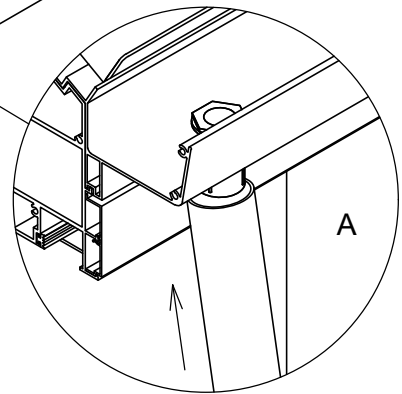

7C33-S03



B



A

Part	NO.	QTY.	Length(MM)
	7B33-016	2	PCS
	7C33-005	2	PCS
	7B33-015L	2	PCS
	7B33-015R	2	PCS
	7C33-004	4	PCS
	Za4.2-13	36	PCS

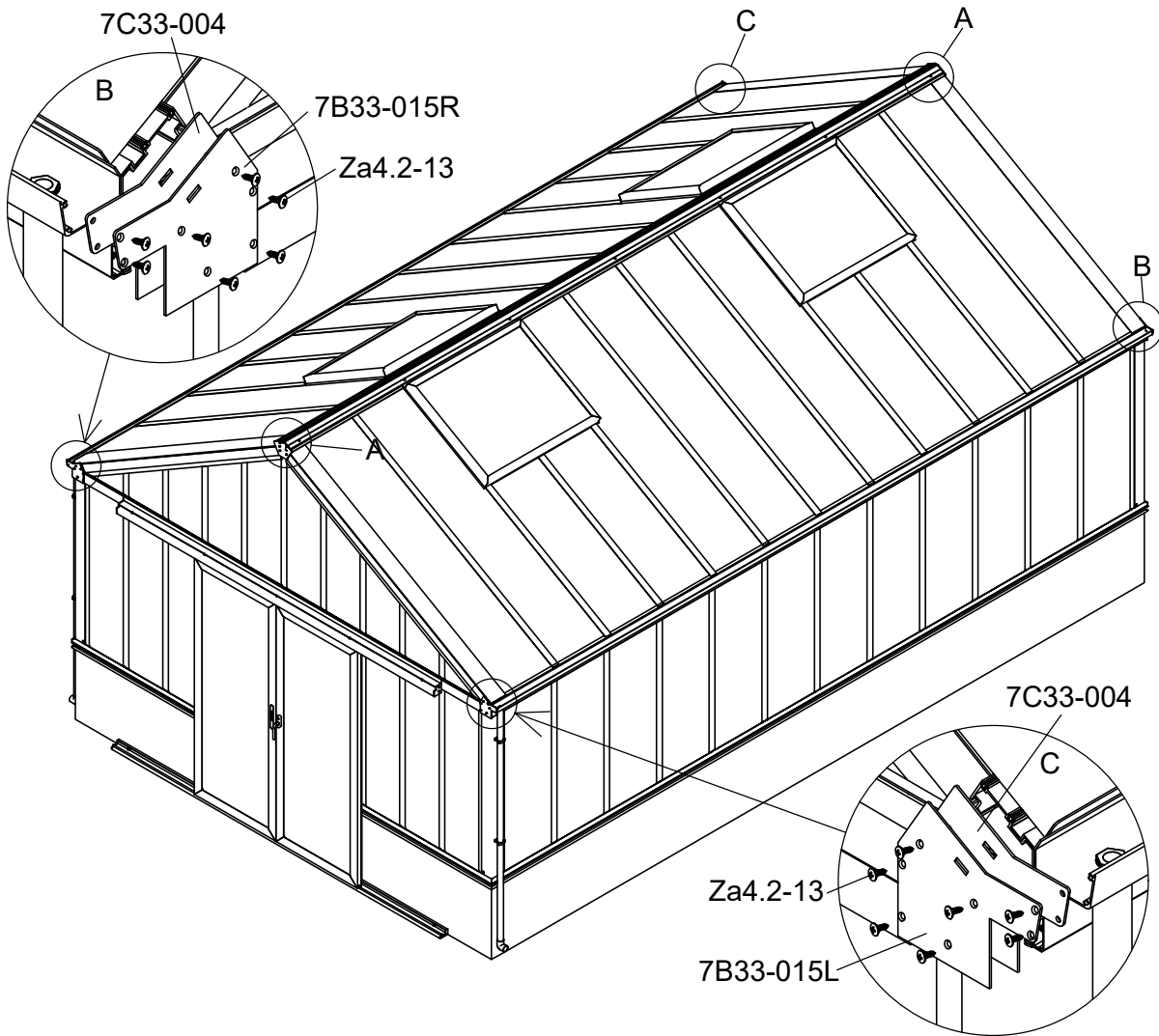
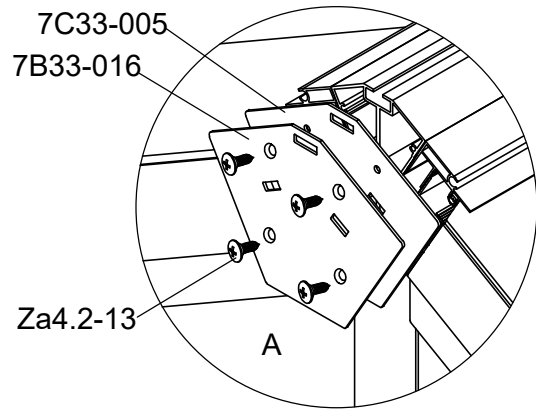

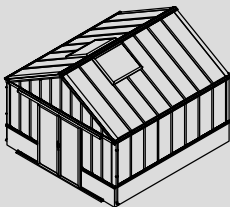
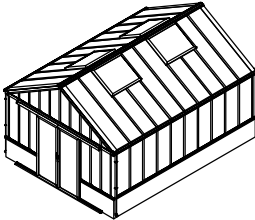
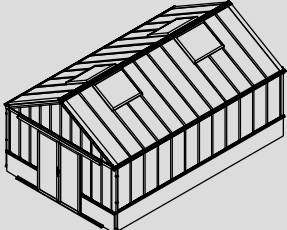
3731	3732	3733
		



Part	3731		3732		3733		Code
	NO.	Length(MM)	NO.	Length(MM)	NO.	Length(MM)	
	41A-Y11-4	4239	41A-Y11-5	5240	41A-Y11-6	6241	A001

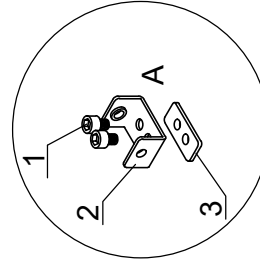
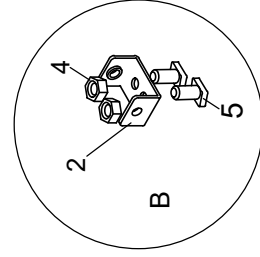
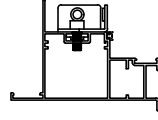
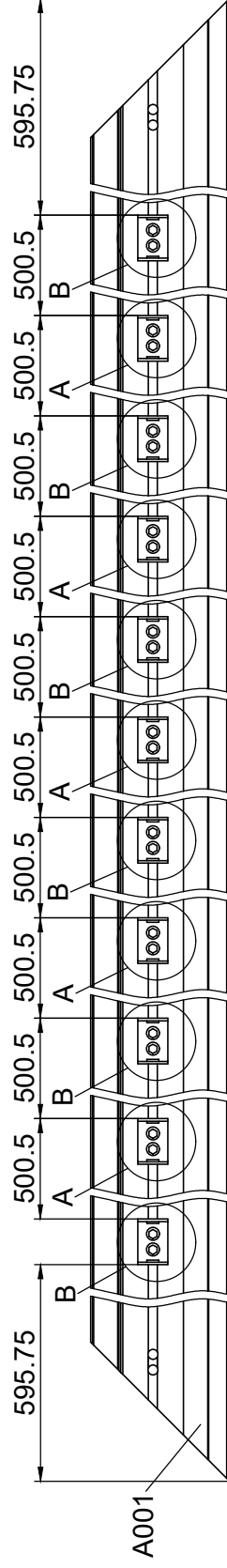

NO.	
1	M8-10
2	7B33-005
3	7B33-004
4	M8
5	Ma8-20

F1

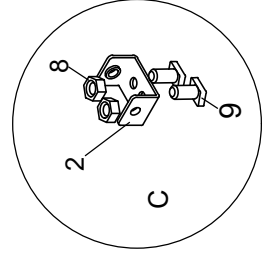
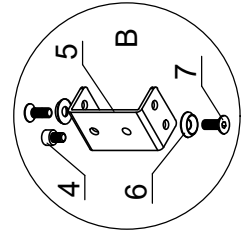
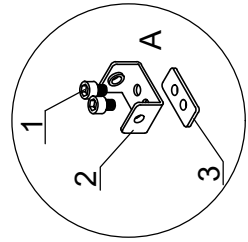
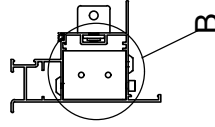
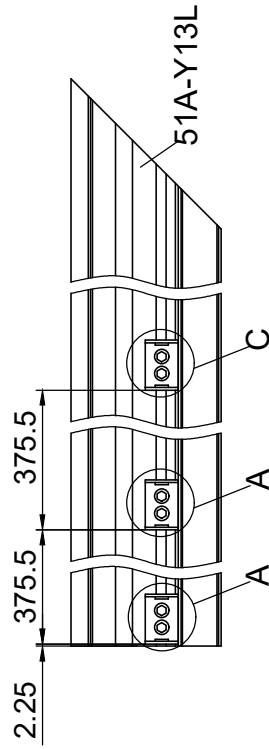
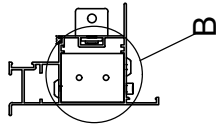
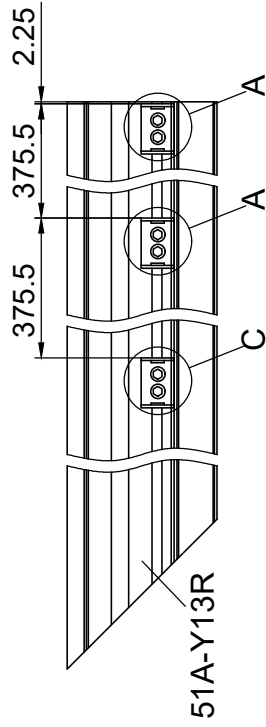
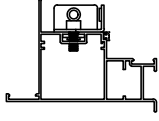
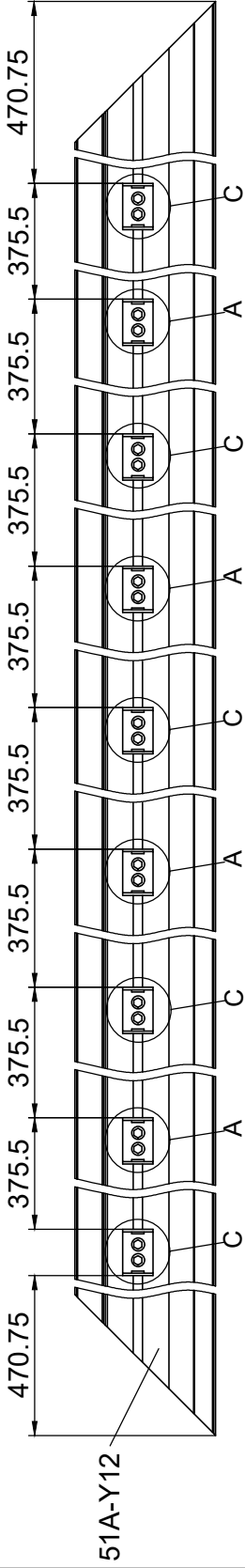

NO.	
1	M8-10
2	7B33-005
3	7B33-004
4	M6-8
5	7B33-047
6	J05
7	Si6-16
8	M8
9	Ma8-20

F2

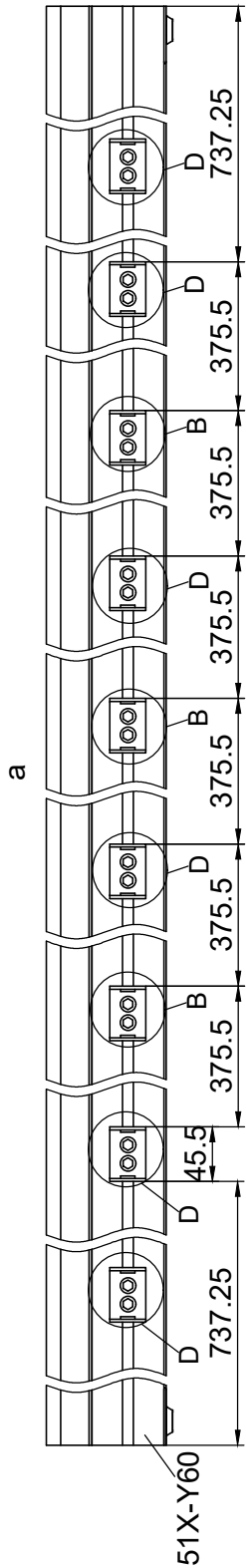
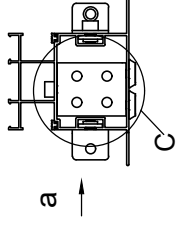
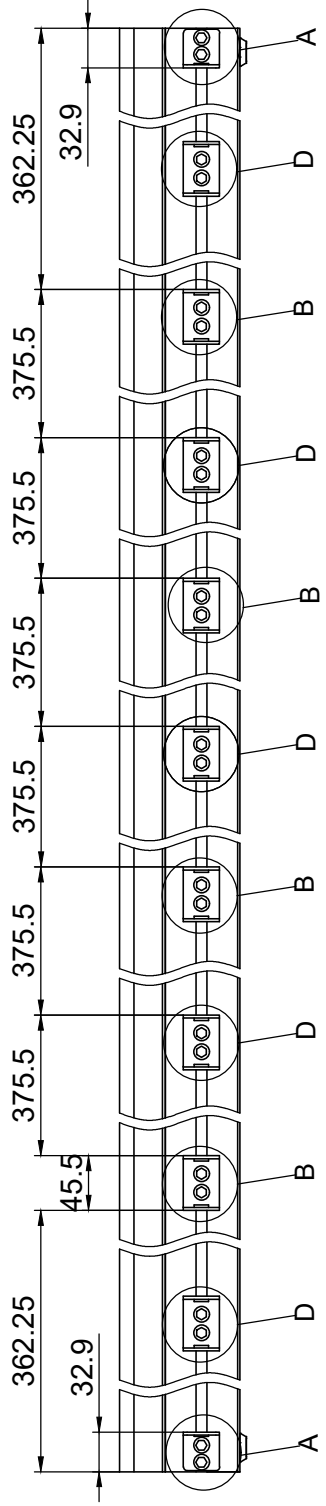

NO.	
1	7B33-006
2	7B33-007
3	M8-10
4	7B33-005
5	7B33-004
6	M8-20
7	7B33-009
8	7B33-020
9	M8-16
10	M8
11	Ma8-20

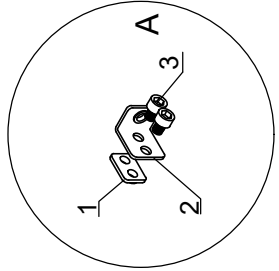
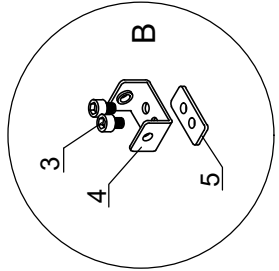
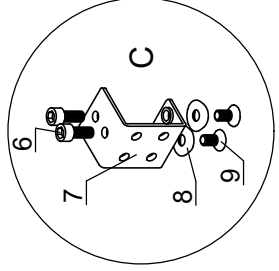
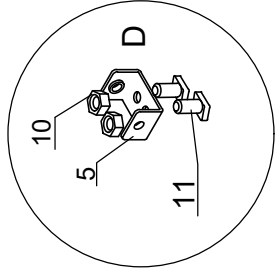

F3

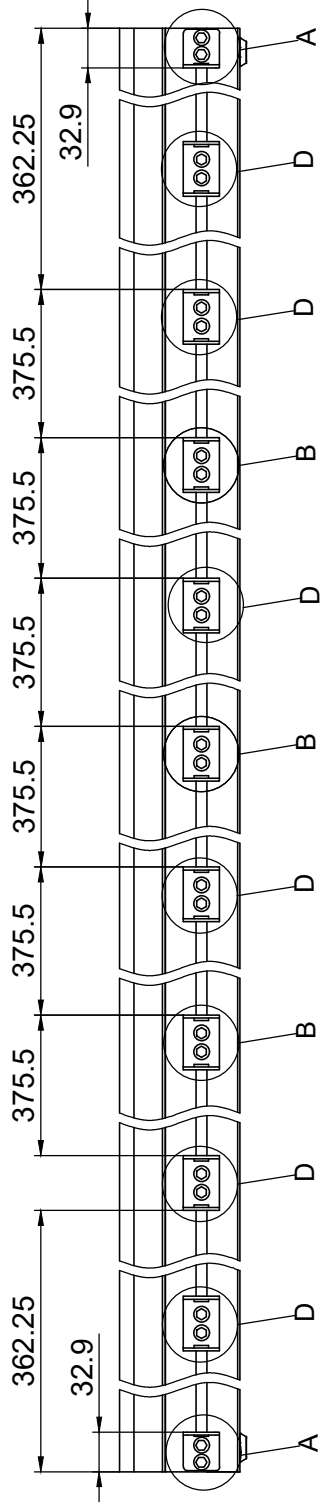

51X-Y61

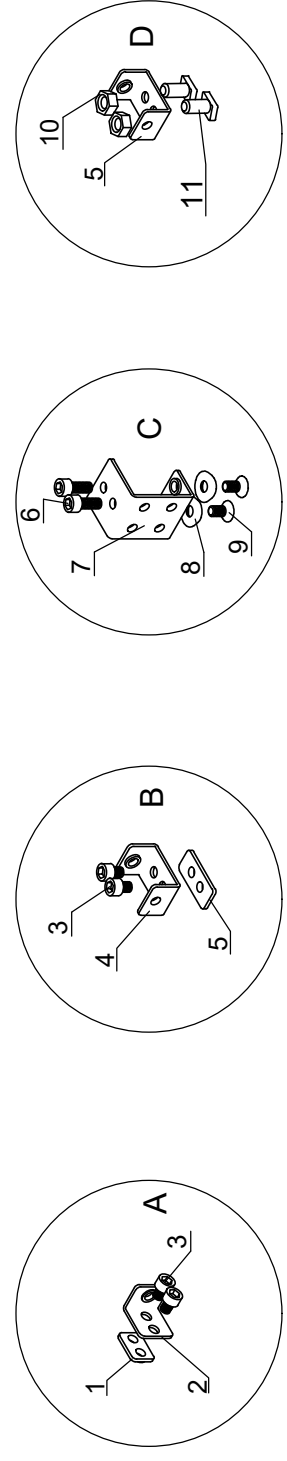
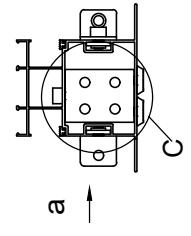
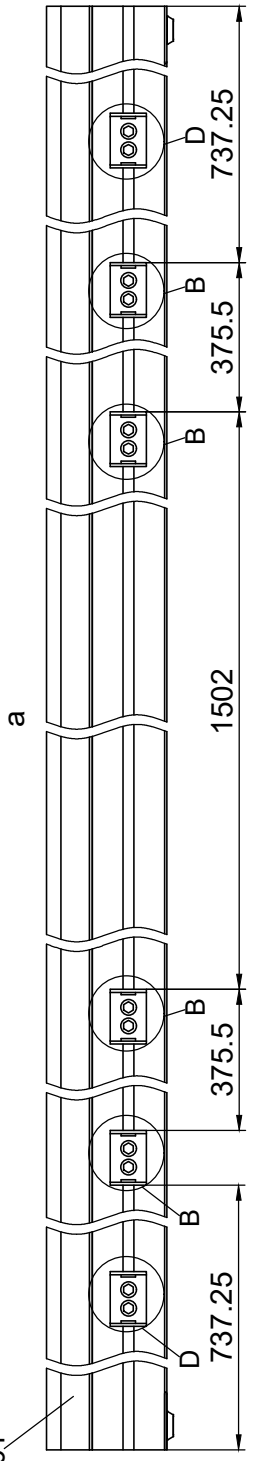

NO.	
1	7B33-006
2	7B33-007
3	M8-10
4	7B33-005
5	7B33-004
6	M8-20
7	7B33-009
8	7B33-020
9	M8-16
10	M8
11	Ma8-20

F4



Part	3731		3732		3733		Code
	NO.	Length(MM)	NO.	Length(MM)	NO.	Length(MM)	
 41X-Y62-4	4228	41X-Y62-5	5229	41X-Y62-6	6230	A002	

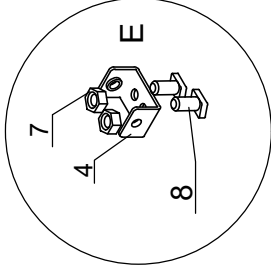
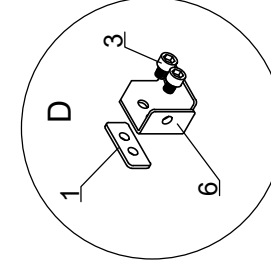
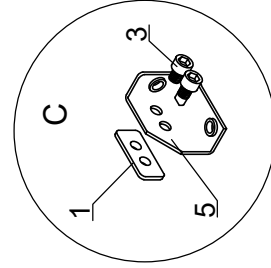
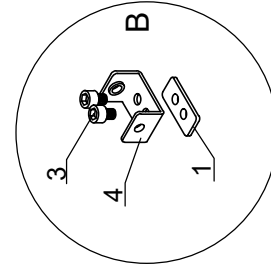
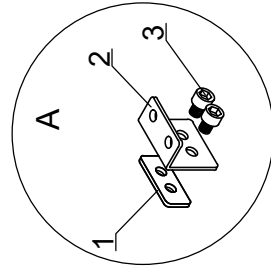
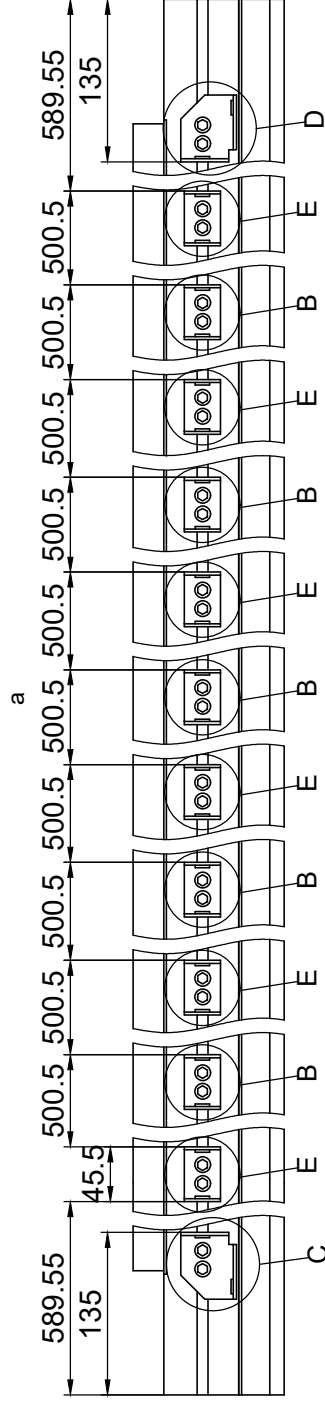
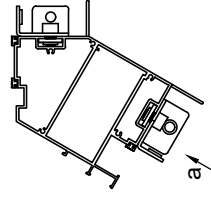
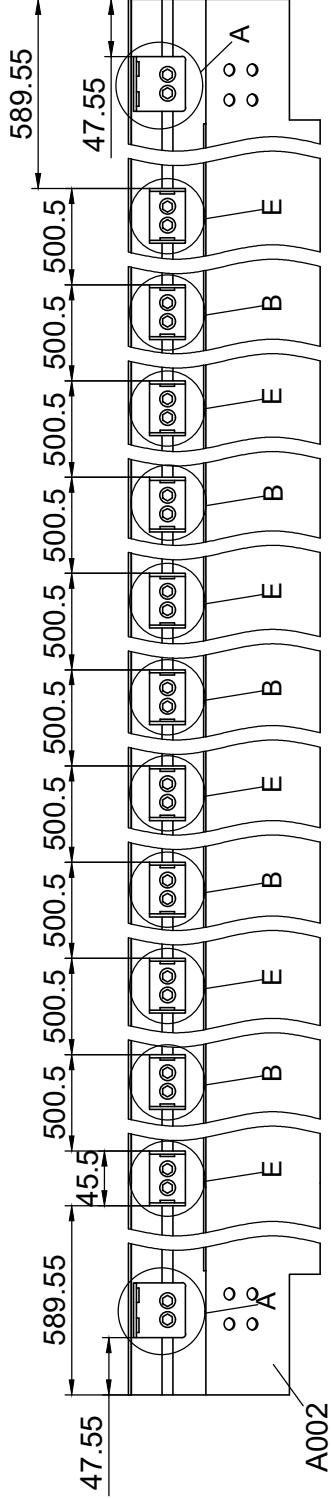

NO.	
1	7B33-004
2	7B33-010
3	M8-10
4	7B33-005
5	7B33-003
6	7B33-002
7	M8
8	Ma8-20

F5



Part	3731		3732		3733		Code
	NO.	Length(MM)	NO.	Length(MM)	NO.	Length(MM)	
	41X-Y63-4	4207	41X-Y63-5	5208	41X-Y63-6	6209	A003

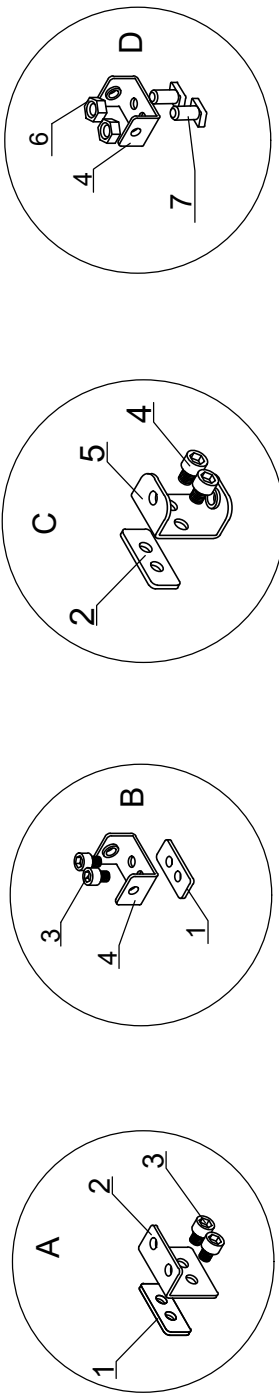
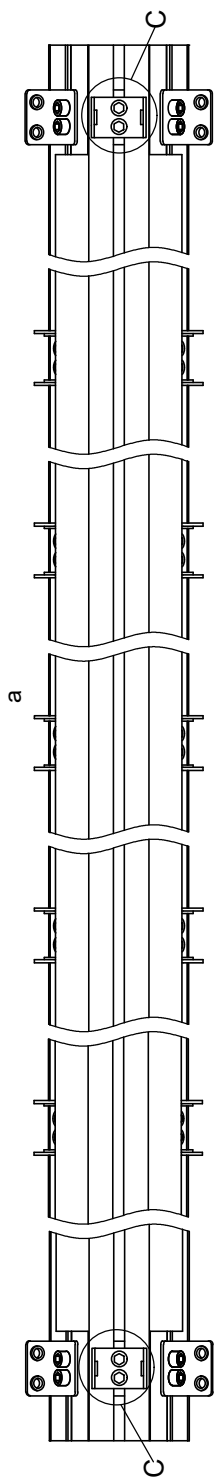
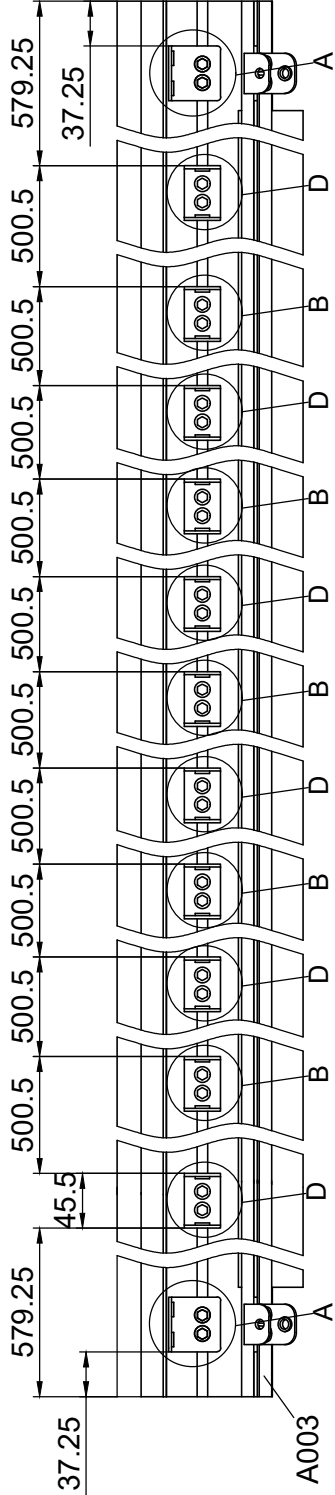

NO.	
1	7B33-004
2	7B33-010
3	M8-10
4	7B33-005
5	7B33-011
6	M8
7	Ma8-20

F6

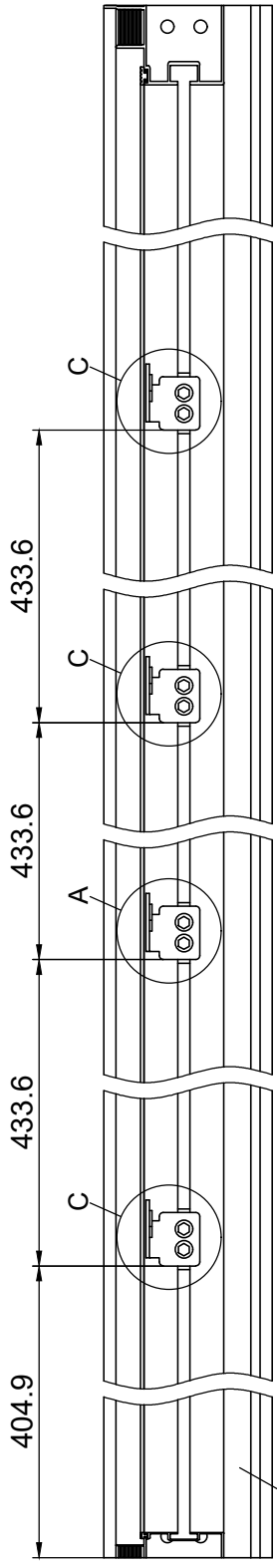

51X-Y21

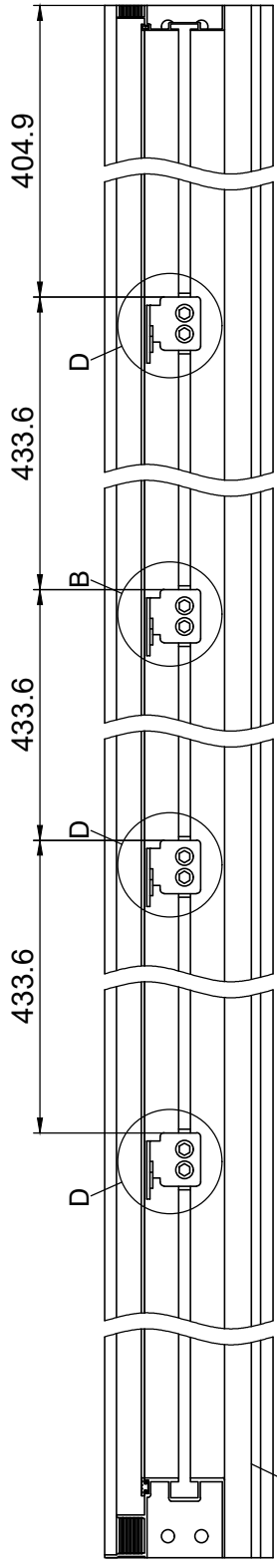

51X-Y22

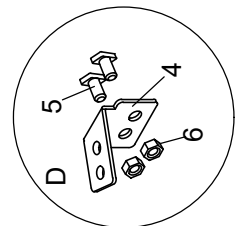
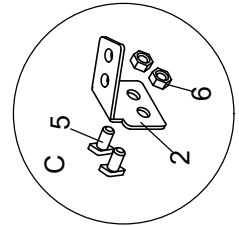
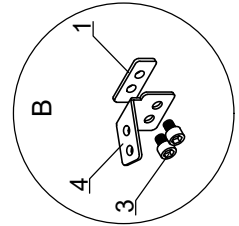
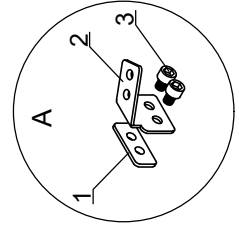
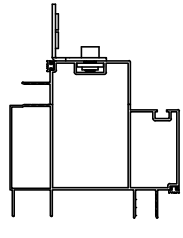
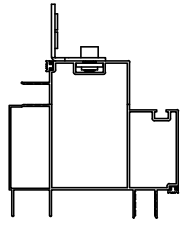

NO.	
1	7B33-004
2	7B33-013R
3	M8-10
4	7B33-013L
5	Ma8-20
6	M8

F7

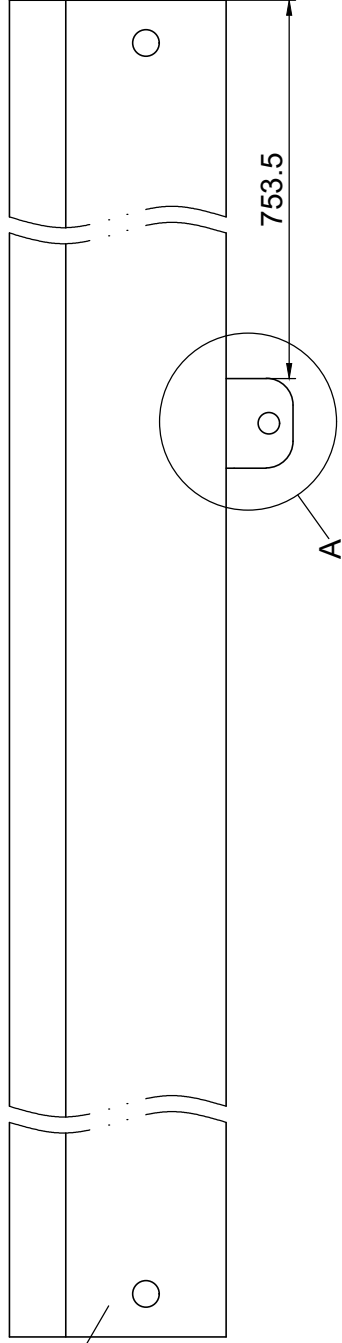

51X-Y33

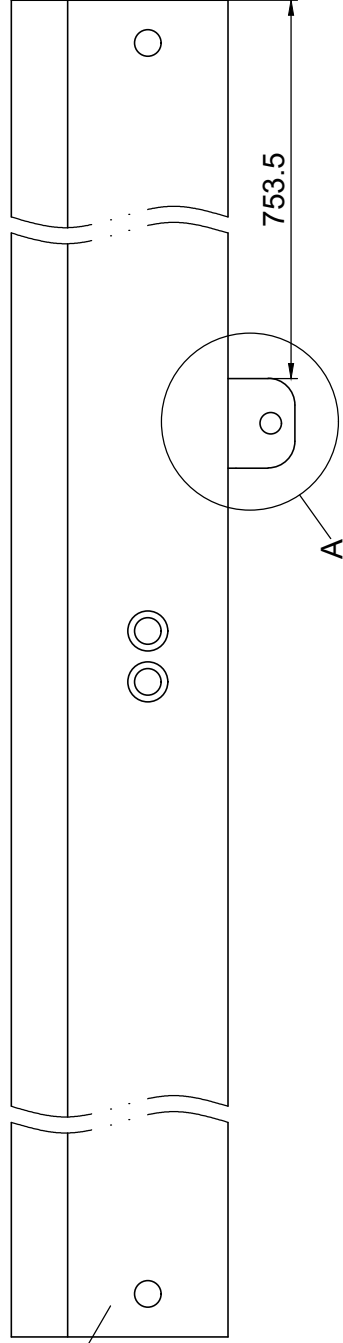
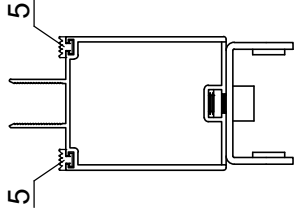

51X-Y33R

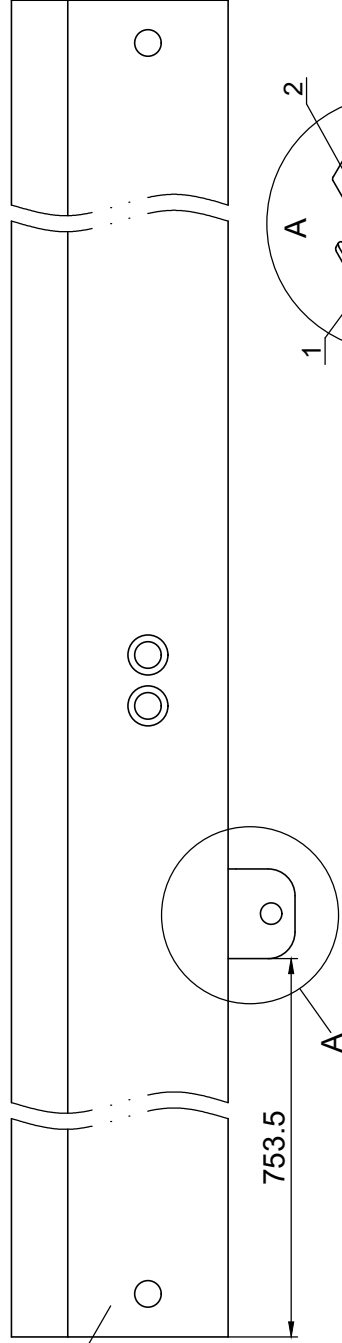
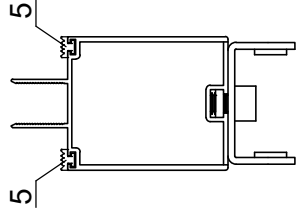

51X-Y33L

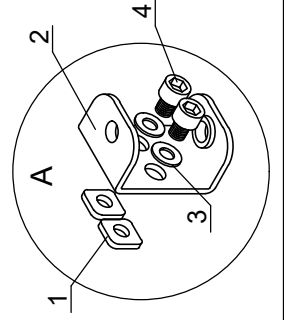
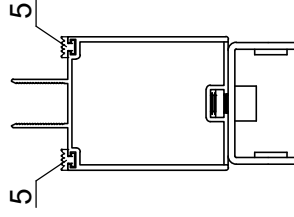

NO.	
1	MF6
2	7B33-011
3	MD6
4	M6-8
5	7C33-002

F8